



## Energy Services

—

2019

## Market Intelligence Report

—





### GreenCape

GreenCape is a non-profit organisation that works at the interface of business, government and academia to identify and remove barriers to economically viable green economy infrastructure solutions. Working in developing countries, GreenCape catalyses the replication and large-scale uptake of these solutions to enable each country and its citizens to prosper.

### Acknowledgements

We thank Reshmi Muringathuparambil (lead author), Jack Radmore, Bruce Raw, Seraj Chilwan, Michael Leighton, Khanyiselo Kumalo, and Ian Scrimgeour for the time and effort that they have put into compiling this market intelligence report.

### Disclaimer

While every attempt has been made to ensure that the information published in this report is accurate, no responsibility is accepted for any loss or damage to any person or entity relying on any of the information contained in this report.

Copyright © GreenCape 2019

This document may be downloaded at no charge from [www.greencape.co.za](http://www.greencape.co.za). All rights reserved.

Subscribe to receive e-mail alerts or GreenCape news, events, and publications by registering as a member on our website: [www.greencape.co.za](http://www.greencape.co.za)

Cover image courtesy of New Southern Energy



18 Roeland Street, Cape Town, 8001, South Africa

Editorial and review: Salomé Bronkhorst, Jack Radmore  
and Nicholas Fordyce

Images: GreenCape, City of Cape Town and New Southern Energy

Layout and design: Tamlin Lockhart Art Direction

# Contents

Executive summary	2
What's new	3
1. Introduction and purpose	4
2. Sector overview	6
2.1. Market context	6
2.1.1. Decentralised renewable energy	6
2.2. Market opportunities	7
2.3. Market drivers	7
2.3.1. Rising electricity costs	8
2.3.2. Falling costs of renewable energy technologies	8
2.3.3. Supportive energy policies and regulations by local and national government	10
2.3.4. Innovative finance facilitating the right type of finance into the sector	16
2.3.5. Accreditation bodies are assuring the technical competence of installers	18
2.4. Key players	19
2.5. Governance	21
2.5.1. National government	21
2.5.2. Local government	21
2.5.3. Industry bodies	21
2.6. Total available ES market size	21
2.6.1. Rooftop solar photovoltaic (PV) market size	21
2.6.2. Energy storage market size	22
2.6.3. Energy efficiency market size	25
3. Legislation, regulation and policy	28
3.1. Legislation and regulation	28
3.2. Policy	29
4. Emerging opportunities, drivers and barriers	32
4.1. Commercial off-the-shelf systems	32
4.2. Rooftop PV system bundling through contract standardisation	33
4.3. Secondary market for PV system components	34
4.4. Modernisation of buildings for energy efficiency	35
5. Funding and incentives	38
5.1. General database web page	38
5.1.1. Green finance database	38
5.1.2. Government funding and incentive database	38
5.1.3. Finfind database	38
5.1.4. AlliedCrowds database	38
6. The Western Cape: Africa's green economy hub	40
7. GreenCape's support to businesses and investors	44
8. References	46

# List of figures

<b>Figure 1:</b> ES sector overview	7
<b>Figure 2:</b> Average Eskom tariff versus inflation (CPI) projected to 2019	8
<b>Figure 3:</b> International levelised cost of electricity (LCOE) per renewable energy technology and Eskom average tariff trajectory 2010-2017 (Rand/kWh)	9
<b>Figure 4:</b> PV price curve for systems smaller than 100 kW <sub>p</sub> (left) and larger than 100 kW <sub>p</sub> (right), projected to 2020	10
<b>Figure 5:</b> Municipalities' wheeling framework	11
<b>Figure 6:</b> Electricity trading structure	12
<b>Figure 7:</b> Uptake of SSEG processes in municipalities	13
<b>Figure 8:</b> PACE financing mechanism	17
<b>Figure 9:</b> ES market value chain	19
<b>Figure 10:</b> Distribution of solar PV installations across end-user segments in South Africa	22
<b>Figure 11:</b> Eight services are applicable in the South African energy storage context	23
<b>Figure 12:</b> Behind-the-Meter energy storage cost trajectory per technology 2014-24	24
<b>Figure 13:</b> 2015 energy consumption in South Africa (GWh)	26
<b>Figure 14:</b> IRP 2018 Allocations	30
<b>Figure 15:</b> Average cost breakdown of PV system components	32
<b>Figure 16:</b> GreenCape's focus areas	45

# List of tables

<b>Table 1:</b> Provincial breakdown of SSEG uptake	14
<b>Table 2:</b> List of municipalities allowing SSEG to connect to the grid	15
<b>Table 3:</b> Roles of key players in the ES value chain	20
<b>Table 4:</b> Total energy savings opportunities and capital leveraged for small and large businesses identified by the PSEE programme	25

# List of abbreviations and acronyms

B-BBEE	Broad-Based Black Economic Empowerment
BoS	Base of System
Capex	Capital expenditure
CCA	Customs-controlled area
CO <sub>2</sub> e	Carbon Dioxide equivalent
CoCT	City of Cape Town
COTS	Commercial Off-the-shelf
C&I	Commercial and industrial
CMVP	Certified measurement and verification personnel
CPI	Consumer price index
CSP	Concentrated solar power
DEADP	Department of Environmental Affairs and Development Planning (Western Cape)
DEDAT	Department of Economic Development and Tourism (Western Cape)
DFI	Development Finance Institution
DoE	Department of Energy (National)
DPE	Department of Public Enterprises
dti	Department of Trade and Industry
EE	Energy efficiency
EG	Embedded generation
EPC	Engineering Procurement Construction
EPCM	Engineering Procurement Construction Management
ERA	Electricity Regulation Act
ES	Energy services
ESC	Energy supply contracting
ES <sub>t</sub>	Energy storage
ESCo	Energy services company
ETI	Employment tax incentive
FDI	Foreign Direct Investment
GIB	Green Investment Bank
GIZ	Deutsche Gesellschaft für Internationale Zusammenarbeit GmbH (German Society for International Cooperation)
GOF	Green Outcomes Fund
GTIP	Green Tourism Incentive Programme
GW	Gigawatt
GWh	Gigawatt-hours
HVAC	Heating Ventilation and Cooling
IDC	Industrial Development Corporation
IEA	International Energy Agency
IEP	Integrated Energy Plan
IFC	International Finance Corporation
IPP	Independent Power Producer
IRENA	International Renewable Energy Agency
IRP	Integrated Resource Plan
kW	kilowatt
kWh	kilowatt-hours
kW <sub>p</sub>	kilowatt-peak
LCOE	Levelised Cost of Electricity
MIR	Market Intelligence Report
Mt	Megatonnes
MW	Megawatt

MWh	Megawatt-hours
MW <sub>p</sub>	Megawatt-peak
MYPD	Multi Year Price Determination
NBI	National Business Initiative
NCPCC-SA	National Cleaner Production Centre South Africa
NEES	National Energy Efficiency Strategy
NERSA	National Energy Regulator of South Africa
OEM	Original Equipment Manufacturer
P4 Platform	PQRS PV Performer Platform
PACE	Property Assessed Clean Energy
PAYS	Pay As You Save
PPA	Power Purchase Agreement
PQRS	Power Quality and Renewable Services
PSEE	Private Sector Energy Efficiency
PV	Photovoltaic
RE	Renewable Energy
REIPPPP	Renewable Energy Independent Power Producers Procurement Programme
ROI	Return on Investment
SALGA	South African Local Government Association
SANEDI	South African National Energy Development Institute
SANS	South African National Standard
SAPVIA	South African Photovoltaic Industry Association
SAWEA	South African Wind Energy Association
SEZ	Special Economic Zone
SME	Small- and Medium-sized Enterprise
SSEG	Small-Scale Embedded Generation
StatsSA	Statistics South Africa
TWh	TerraWatt-hour
VAT	Value added tax
VCC	Venture Capital Company

## Exchange rate used

1 USD = R13.63 (December 2017)



# Executive summary

**This market intelligence report is written for investors, equipment suppliers, project developers, and technical advisors. It highlights opportunities in embedded generation and energy efficiency created by South Africa's diversifying energy services market.**

The term 'energy services' (ES) is used to describe two key energy market segments in the South African energy space, namely (i) small-scale embedded generation (SSEG), which includes rooftop solar photovoltaic (PV) systems and energy storage, and (ii) energy efficiency. These market segments are increasingly bolstered by offerings in the energy finance sector, which in and of themselves also present opportunities to financial investors.

There are a number of factors driving growth in the SSEG and energy efficiency markets. Many individuals, businesses, industry and government have been motivated by the following factors to adopt alternative energy service options:

- above-inflation electricity price rises;
- decreasing technology costs;
- supportive policies, regulations and tariffs (wheeling and small scale embedded generation);
- innovative finance options; and
- service provider accreditation.

These drivers are creating four notable emerging opportunities beyond the considerable growth of the ES market:

The national embedded generation market for installations, operation and maintenance of **rooftop solar PV** has grown in the last two years. It is expected that the total annual available market could grow to a saturation point of ~500 MW<sub>p</sub> installed per year on an ongoing basis. This market could reach a total of 7.5 GW of installed capacity by 2035. At a cost of R10/W<sub>p</sub> this installed capacity growth represents a total available market of R5 billion a year and a total available market of R75 billion by 2035. The installation of an additional 500 MW<sub>p</sub> in one year translates to the potential creation of ~1 250 jobs.

With increasing demand in embedded generation, the SA **energy storage** market is also expected to grow. The potential market is made up of mostly grid management and resource adequacy applications. For the latter, the market is estimated to reach R15–30 billion by 2030. For demand-side management and back-up power, this market is expected to be valued at ~R5 billion by 2035. The energy storage market is expected to become the keystone of the future energy services market.

**Energy efficiency** presents a significant opportunity to investors and businesses in all sectors. The estimated annual total available market currently stands at R3 billion, estimated to reach R21 billion by 2035.

Within embedded generation, there are three emerging opportunities for investors:

- **Commercial off-the-shelf systems** are an opportunity for ESCOs, EPCs and EPCMs because they reduce the overall cost of systems by reducing the need for bespoke design and engineering.
- **Bundling of rooftop PV systems** is an opportunity for project developers because it results in reduced transaction costs and less risk.
- The development of a **secondary market for PV components** presents an interesting opportunity for EPCs and resellers to open the market to those customers who could not previously afford a new system.

Within energy efficiency, the emerging opportunity is that of **modernisation of existing buildings**, aimed at ESCOs who specialise in energy efficiency measures such as lighting, HVAC and smart metering.

# What's new?

**This MIR provides an update on the opportunities, barriers and regulations discussed in the 2018 Energy Services MIR. It also outlines emerging opportunities and barriers in small-scale embedded generation and energy efficiency.**

New or updated content covered in this MIR includes:

- Local government has facilitated the growing uptake of SSEG by making three major changes. Drivers such as wheeling of energy, electricity trading, and the national rollout of SSEG rules, regulations and tariffs are detailed in [Section 2.3.3](#).
- Energy finance mechanisms such as PACE, commercial banks, and PAYS are presented in [Section 2.3.4](#) as drivers within the energy services sector.
- SSEG in the Integrated Resources Plan 2018: A draft IRP 2018 was released for comment in August 2018. The updated document allocates 200 MW per annum for embedded generation for own use of between 1 MW and 10 MW, starting in 2019. This is discussed further in [Section 3.2](#).
- Emerging opportunities within the embedded generation and energy efficiency markets, as well as their drivers and barriers are outlined in [Section 4](#). These opportunities include commercial off-the-shelf systems; rooftop PV bundling; secondary market for PV components; and modernisation.

# 1

## Introduction and purpose

**In response to changing demands, energy service providers are broadening their market offerings. The South African energy services market holds opportunities for equipment suppliers, project developers, technical advisors, and financial investors.**

This MIR provides an update on opportunities identified in the 2018 MIR. It highlights emerging opportunities in embedded generation (rooftop solar PV and energy storage), and energy efficiency in South Africa.

The **sector overview** (Section 2) provides a national and provincial economic overview of the energy services market, including the growth drivers, key industry players and size of the market. This is followed by an overview and update of **legislation, regulations and policies** (Section 3) that guide and affect the ES market. In Section 4, **emerging opportunities and their related drivers and barriers** are highlighted, followed by sections that outline various **finance and investment incentives** (Section 5), present the case for the **Western Cape as a potential greentech hub** for Africa (Section 6), and explain **GreenCape's work within the green economy** (Section 7).

For questions, queries or to access GreenCape's services, contact the energy services team at: [ES@greencape.co.za](mailto:ES@greencape.co.za)



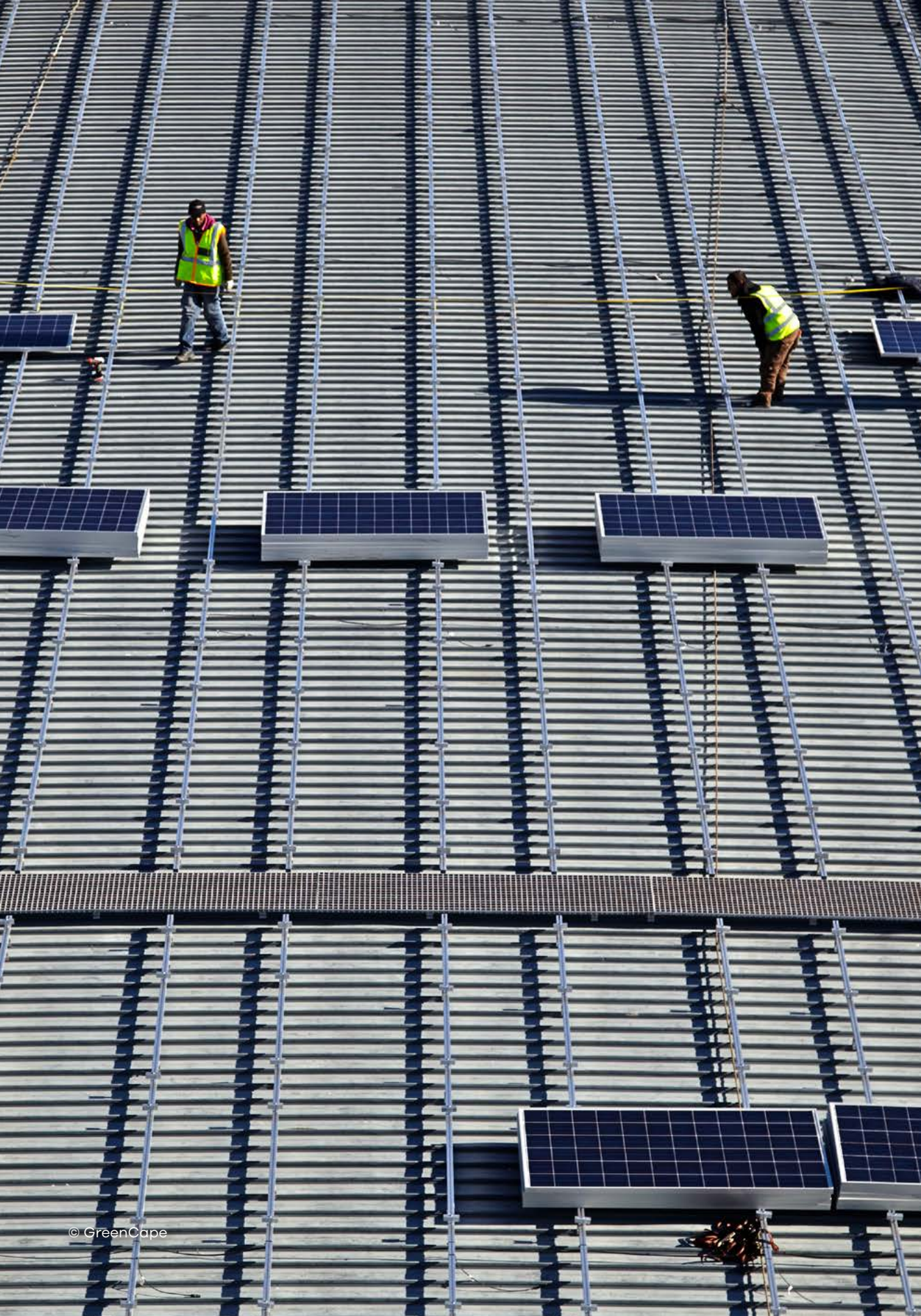

# 2

## Sector overview

**Rising electricity prices, dropping technology costs, numerous supportive energy policies and incentives are prompting consumers to explore alternative energy options. These factors form the major drivers of the energy services (ES) market in South Africa.**

This section provides an overview of the national and provincial ES context, covering market developments, key industry players, and the size of the market.

### 2.1. Market context

The South African electricity mix is primarily made up of coal assets, because of limited technology options in the past and South Africa's abundant supply of coal. South Africa used 251 million tonnes of coal in 2016, the seventh most in the world, and coal power currently represents over 90% of the total electricity supply. The rest of the electricity is provided by nuclear, hydro and, recently, renewable energy.

The South African electricity market is currently managed on a single operator model by the state-owned entity, Eskom, which is responsible for generation and transmission, and which also controls a minority share of the distribution market. This single operator model is designed to support developing electricity markets in need of structured long-term infrastructure investments (with 10 – 15 year construction timelines) and diverse demand balancing of centralised resources.

South Africa's dependence on this single buyer/operator model has decreased over the past 10 years with the introduction of new technologies, which are cheaper, capable of being decentralised, and more environmentally friendly.

#### 2.1.1. Decentralised renewable energy

South Africa's renewable energy market has exploded over the last eight years after the

inauguration of the Independent Power Procurement (IPP) office in 2010. The REIPPPP has been lauded globally for its clear mandate, growth path and independence of its procurement approach. The success of REIPPPP is evident in a tariff decline of more than 150% over five years, with the levelised cost of electricity for wind and solar in most recent expedited rounds coming in at less than R0.62/kWh. Each REIPPPP bid window has also seen a major oversubscription in tender submissions from numerous local and international developers and investors.

To date, the programme has attracted more than R200 billion in investment, of which R48.7 billion is foreign equity and financing activities. The six bid windows will create 39 537 fulltime equivalent jobs for South African citizens. Shareholding by South Africans has accounted for 48% in projects, with an average of 31% of project equity benefiting Broad-Based Black Economic Empowerment for South Africans.

Beyond these successes, the industry has experienced significant difficulties over the past three years<sup>1</sup>. Uncertainties highlight the need for reforms in an evolving energy sector, where electricity generation, transmission, and distribution systems require unbundling. This shifting power sector structure, away from the single operator model, is nowhere more evident than in the energy services market, which is creating decentralised 'PROsumers'<sup>2</sup> in the South African electricity market.

<sup>1</sup> For more information, please see our Utility Scale Renewable Energy MIR.

<sup>2</sup> A prosumer is an entity or person who produces and consumes a product, in this case electricity.



## 2.2. Market opportunities

The term 'energy services' is used to describe two interlinked energy market segments in the South African energy space, namely small-scale embedded generation (SSEG), which includes rooftop solar photovoltaic (PV) systems and energy storage, and energy efficiency.

As shown in the framework for the ES sector presented in Figure 1, and discussed in greater detail in Section 4, there are three emerging rooftop solar PV market opportunities:

- **Bundling of rooftop PV** projects for larger investors;
- plug-and-play **system standardisation**; and
- **secondary markets** for rooftop PV system components.

An emerging energy efficiency opportunity is the **modernisation of existing buildings**.

Opportunities and offerings in the green finance sector bolster opportunities in the whole energy services market. The figure also shows in which sections different opportunities or drivers are discussed in more detail.

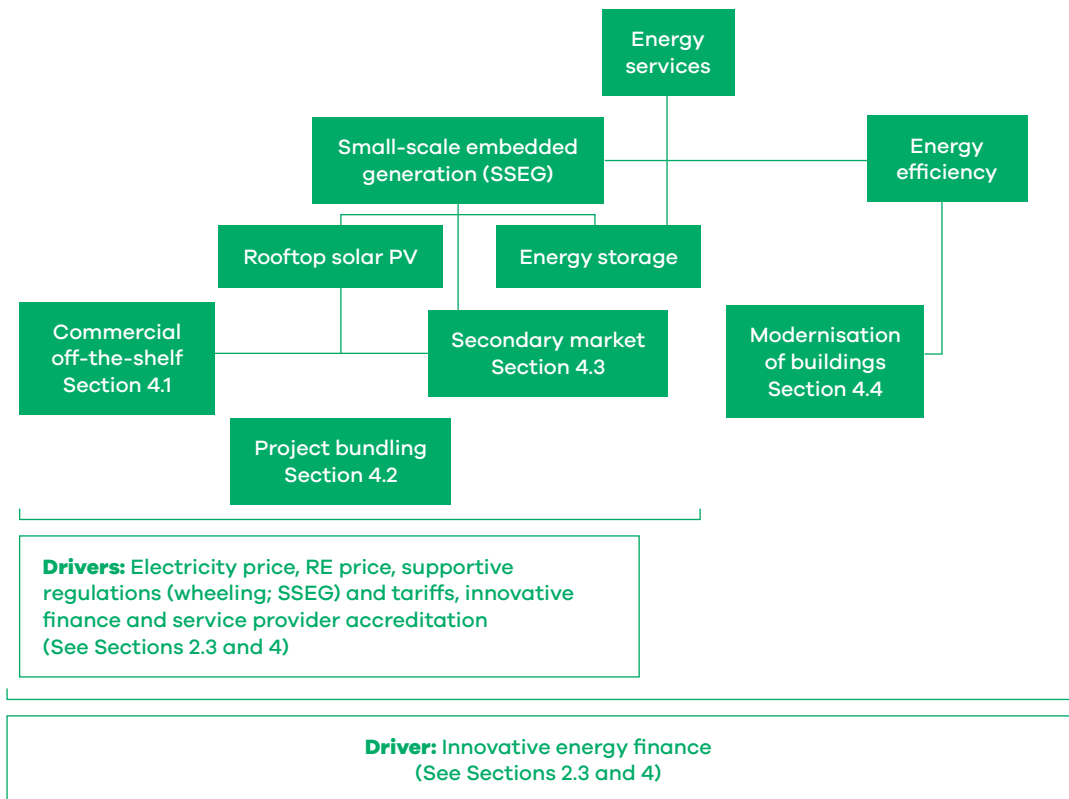

Figure 1: ES sector overview

## 2.3. Market drivers

Five major developments are transforming South Africa's energy market from a monopoly model to a distributed generation model made up of multiple smaller generators, buyers, and sellers:

- rising energy prices;
- falling costs of renewable energy technologies such as rooftop solar PV;
- supportive energy policies and regulations by local and national government;

- innovative energy financing programmes and incentives; and
- accreditation bodies assuring the technical competence of installers.

In turn these developments, discussed in more detail below, create significant opportunities for renewable energy investors and businesses, in particular equipment suppliers, project developers, technical advisors and financial investors.

### 2.3.1. Rising electricity costs

Rapidly rising Eskom electricity prices have created a sizeable demand for viable alternative energy sources. Figure 2 compares Eskom price

increases to the more conservative increase in South Africa's inflation (as reflected by the Consumer Price Index).

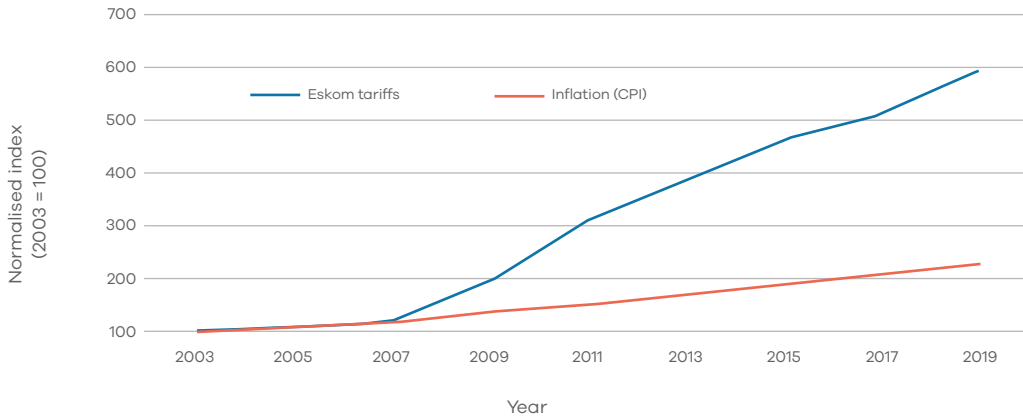

**Figure 2: Average Eskom tariff versus inflation (CPI) projected to 2019**

Sources: Statistics South Africa (StatsSA) and Eskom (2018)

The National Energy Regulator of South Africa (NERSA) has approved Eskom's Regulatory Clearing Account application for 2014/15, 2015/16 and 2016/17. It allows Eskom to retrieve *justifiable* costs retrospectively by adding them to future years' tariffs. For the next three years, from 2019/20, this translates to ~4.41% increase per year. This is over and above any tariff increase which is approved by NERSA for a given period.

Under Multi Year Price Determination 4 (MYPD4), Eskom has made an application to NERSA for a further 15% tariff increase from 2019/20 to 2021/22, and is projecting 10% for each of the following two years. This excludes the R32.69 billion that Eskom will be allowed to "claw back" for unanticipated cost overruns for the period 2014/15 to 2016/17 through the Regulatory Clearing Account.

If this application is approved, this would translate to an increase in Eskom tariffs of over 300% since 2009. Historical data from both Eskom (2018) and StatsSA (2018), shown in Figure 2, reveal that while inflation has almost doubled since 2009, Eskom prices have tripled over the same period.

### 2.3.2. Falling costs of renewable energy technologies

Renewable energy technology prices have been dropping steadily since 2010. Figure 3 shows the average international levelised cost of electricity (LCOE) per renewable energy technology and the average Eskom tariff in 2010 and 2017. For example, the global average price for solar PV in 2017 was R1.36/kWh, down from R4.91/kWh in 2010 (IRENA 2018), a ~72% drop in seven years. The most significant decreases in average cost have been in solar PV and wind technologies.

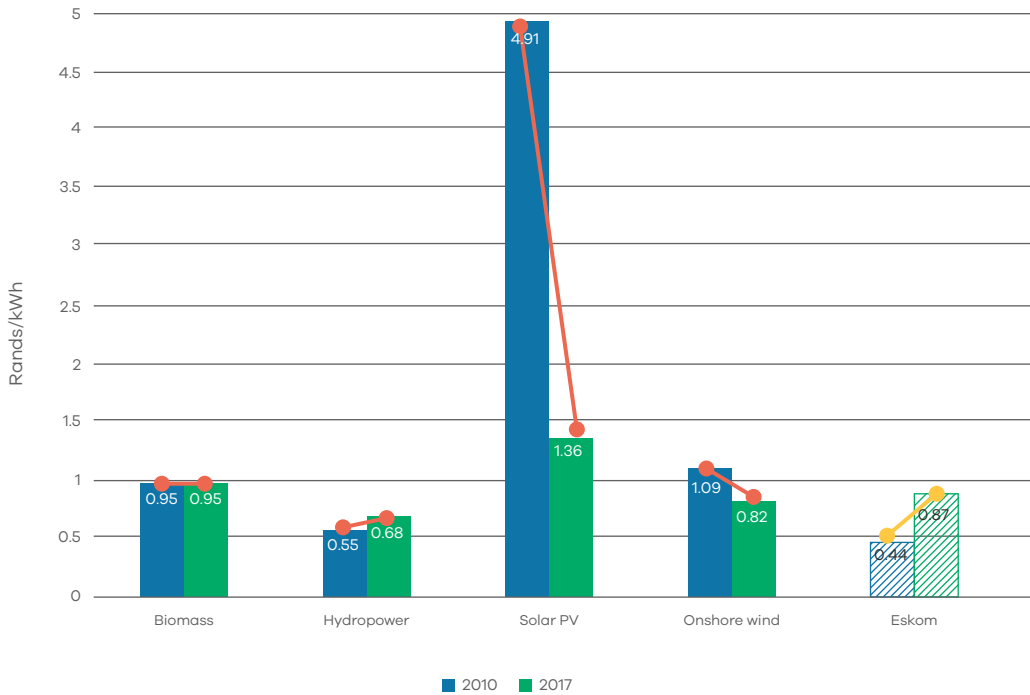

**Figure 3: International levelised cost of electricity (LCOE) per renewable energy technology and Eskom average tariff trajectory 2010-2017 (Rand/kWh)**

Source: Adapted from IRENA (2017)<sup>3</sup>

In South Africa, this trend is also evident in the embedded generation sector, where the levelised cost of solar PV installations has fallen significantly, regardless of size, as depicted in [Figure 4](#). On the other hand, Eskom prices have increased at similar rates, as illustrated in [Figure 2](#) and [Figure 4](#). The dashed lines in [Figure 4](#) represent our conservative forecasts.

<sup>3</sup> Exchange rate: 1 US Dollar = R13.63 (December 2017)



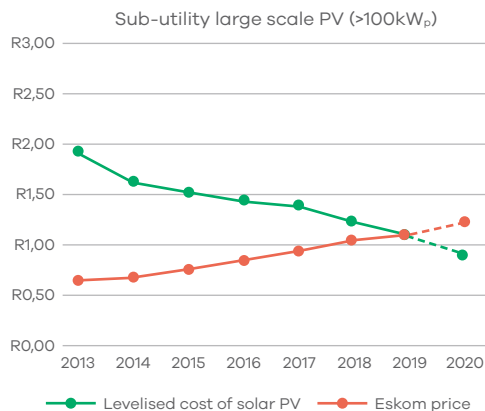
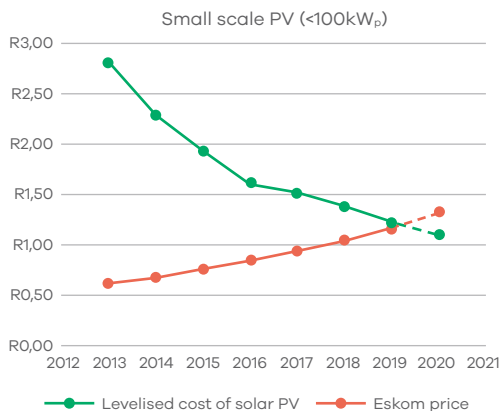

**Figure 4: PV price curve for systems smaller than 100 kW<sub>p</sub> (left) and larger than 100 kW<sub>p</sub> (right), projected to 2020**

Source: GreenCape Analysis and Eskom (2017)

As these costs drop across a variety of ES technologies, the financial case for investment into energy interventions improves.

### 2.3.3. Supportive energy policies and regulations by local and national government

The regulatory environment has a direct impact on investment opportunities, market growth, and job creation. To lower demand on the national grid, and to reduce carbon emissions, national government has put in place several energy policies and incentives to encourage energy efficiency interventions and alternative energy generation. [Section 3](#) (legislation, regulation, and policy) and [Section 5](#) (funding opportunities and incentives) discuss these in more detail.

#### Local government commitment to providing policy certainty

Regulatory developments as described in [Section 3](#) facilitate the growing uptake of renewable energy options, particularly in the <1 MW space – from rooftop solar PV systems and small-scale wind energy installations to the uptake of bioenergy. Similar to the amendments to licensing regulations and guidelines from DoE and NERSA, changes in municipal regulation of SSEG installations have contributed to increasingly

conducive market conditions for investors, project developers, equipment suppliers and technical advisers.

Three major changes are taking place on the local government level:

- **Metropolitan municipalities** around the country, specifically City of Cape Town, Tshwane, City Power (Johannesburg) and Nelson Mandela Bay Municipality, **are challenging the ‘single-buyer’ model**, which restricts the purchase and sale of electricity to Eskom. These municipalities intend to purchase electricity directly from IPPs and on-sell this electricity to their customers<sup>4</sup>.
- **Increasing off-take agreement options** for local embedded electricity generators:
  - Electricity wheeling will allow generators to wheel their electricity to a willing buyer anywhere in the municipality or country.
  - The release of regulations allowing private sector energy trading has also opened the market to private sector power purchase agreements and on-sales to private consumers using the national and local distribution networks.

<sup>4</sup> There is currently a court case to determine if it is within a municipality’s mandate to undertake this role. Further analysis will be included once a ruling has been made.

- **Country-wide rollout of national small-scale embedded generation rules, regulations and tariffs** to promote the safe and legal uptake of SSEG for own use<sup>5</sup>.

These changes at municipal level complement other regulatory changes, e.g. changes in Schedule 2 of the Electricity Regulation Act as detailed in Section 3.1. Together they herald a freer, more 'liberalised' electricity market, in which municipalities and end users will be more empowered in their energy choices.

### Wheeling of electricity

The wheeling of energy is an exciting driver for the uptake of energy services, specifically SSEG, in South Africa. Wheeling is the transportation of

electrical energy from a generator to a separate electrical load, by making use of municipal or Eskom grid infrastructure and Power Purchase Agreements (PPAs). The municipality/Eskom operates in an administrative role to facilitate the transaction between the generators of clean power, and electricity users interested in buying electricity from renewable energy sources (see Figure 5).

**Widespread adoption of wheeling or other frameworks is expected by 2022.**

#### Key

- Eskom
  - Municipality
  - Generator
  - Customer
- M0 Eskom Meter
  - M1 Municipality Check Meter
  - M2 AMI Meter
  - M3 Reversed AMI Meter
  - M4 Generator Check Meter

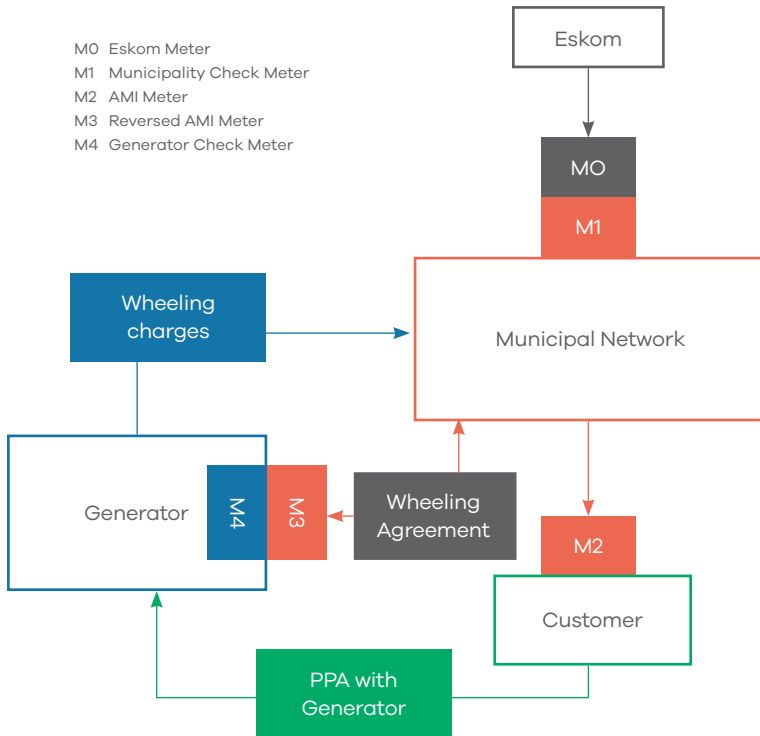

**Figure 5: Municipalities' wheeling framework**

<sup>5</sup> The generation of electricity on the load site where it will also be consumed.

Wheeling has gained a lot of traction in City of Tshwane, Nelson Mandela Bay Metropolitan Municipality and the City of Cape Town over the past year. We expect mass adoption of the framework or similar frameworks by 2022, in much the same way as has been done for nationwide adoption of SSEG regulations and tariffs.

These developments provide SSEG investors with alternative offtake agreements and improved potential returns. It creates new business cases as the opportunity sizing is the consumption profile of the off-taker, not the generation technology. Because the technology is not limited to the user's site, or roof in the case of PV, it will present an opportunity for the following:

- medium-voltage C&I sector profiles, with large energy bills that warrant it;
- buildings that currently are not able to install PV on their rooftop, such as:
- new buildings lacking adequate structural/wind buffer;
- buildings with asbestos roofs that cannot be tampered with, which currently make up a significant portion of older building stock; and
- tenants who do not own the buildings and will struggle to have any structural changes approved.

Despite the obvious benefits to the municipality, there are certain **risks and barriers** to the adoption of this framework:

- Municipalities may not have enough capacity to administer this service.
- The present wheeling tariffs are not yet cost-competitive, but are worked out at an appropriate rate to ensure municipalities do not lose out. Over time, as Eskom's prices continue to rise, the tariffs will adapt.
- Standard national regulation still needs to be developed, accepted by municipalities, and enforced in order to allow for wheeling.
- Initially, wheeling will be limited to customers within a municipality's network. The municipality will remain a net consumer with Eskom, which means that wheeling out of the municipality network adds complications that have yet to be resolved.

In addition to enabling renewable energy technologies, this business model would provide a platform for municipalities to engage and retain customers. Through offering an additional avenue to prosumers, municipalities would propose a new service to electricity generators

as well as consumers interested in procuring clean energy.

### Electricity trading

The release of regulations allowing private sector energy trading has also opened the market to private sector power purchase agreements and on-sales to private consumers using the national and local distribution networks.

Much the same as wheeling, electricity trading is the transportation of electrical energy from a generator to a separate electrical load, by making use of municipal or Eskom grid infrastructure and Power Purchase Agreements (PPAs). The difference is that a private sector electricity trader will purchase the electricity, pay the local municipality/Eskom to wheel it over their network, and sell it to a willing customer. The municipality/Eskom operates in an administrative role to facilitate the transactions, and takes a fee for this service.

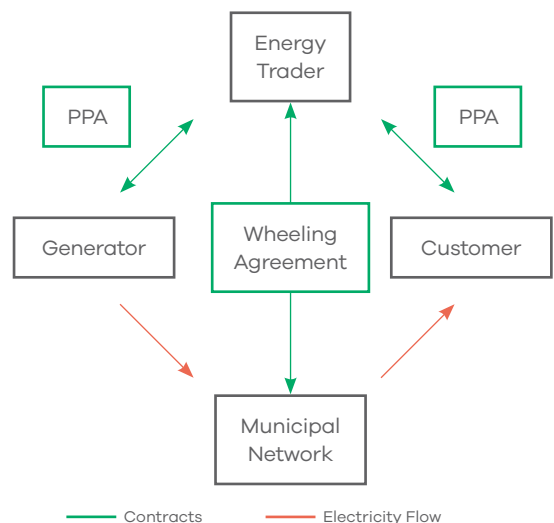

Figure 6: Electricity trading structure

There is currently only one company (PowerX) that has a confirmed national energy trading licence. **This represents both an opportunity for investors in the SSEG market to increase their off-take agreements and reduce their risk profile, and an opportunity for investors interested in investing in other electricity trading entities.**

## Small Scale Embedded Generation (SSEG) regulations and tariffs

Figure 7 represents the best level of information obtained by the South African Local Government Association (SALGA) on the uptake of SSEG processes and tariffs in municipalities by October 2018. Figure 7 shows the upward trend of municipalities adopting SSEG processes. By the end of the 2018/19 financial year, ~42

municipalities in South Africa will have published SSEG regulations<sup>6</sup>, including all eight metropolitan municipalities. Twenty-five of these municipalities also have NERSA-approved SSEG tariffs for one or more customer groups. They represent approximately 15% of all the municipalities that have electricity distribution licences<sup>7</sup>.

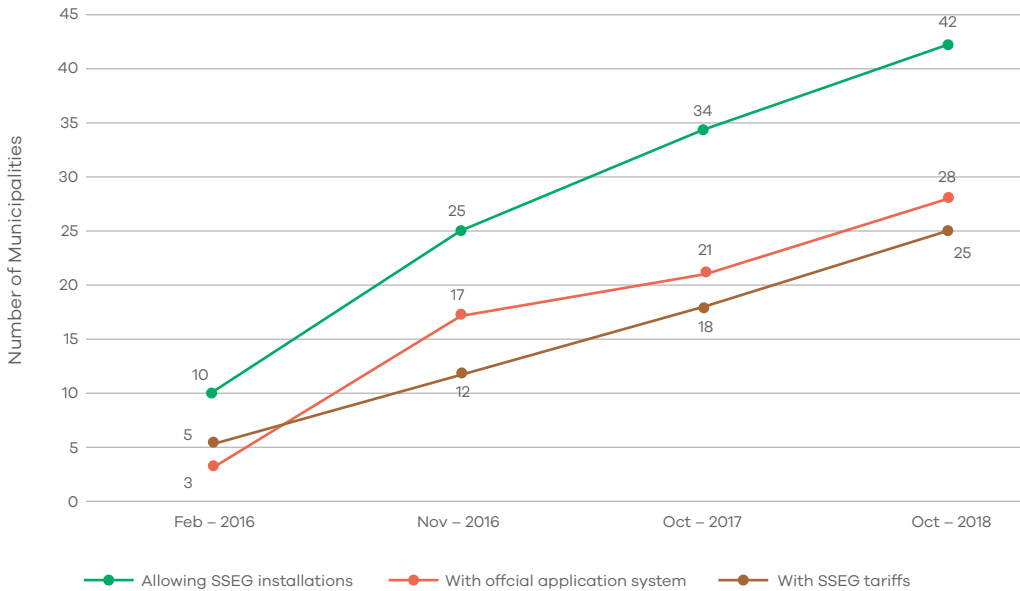

Figure 7: Uptake of SSEG processes in municipalities

Source: SALGA 2018

<sup>6</sup> Municipalities publish these regulations on their individual websites to detail the application process for the safe and legal installation of SSEG systems within the municipal electricity grid.

<sup>7</sup> To see a list of municipalities that allow SSEG, please visit SALGA website <http://www.salga.org.za/Municipalities%20AM.html> – Status of SSEG in SA

Table 1 gives a provincial breakdown of municipalities which allow SSEG installations on their electricity grids, have an application process for customers, and have a NERSA approved tariff.

**Table 1: Provincial breakdown of SSEG uptake**

Province	Number of municipal electricity distributors in the province	Number of municipalities allowing SSEG installations	Number of municipalities with an official SSEG application system	Number of municipalities with SSEG tariffs
Eastern Cape	22	3	2	2
Free State	17	1	1	2
Gauteng	9	4	3	2
KwaZulu-Natal	25	1	1	1
Limpopo	16	3	1	1
Mpumalanga	14	2	1	0
Northern Cape	24	3	1	0
North West	13	1	1	0
Western Cape	25	22	17	17
<b>TOTAL</b>	<b>165</b>	<b>40</b>	<b>28</b>	<b>25</b>
Percentages of licensees <sup>8</sup>		24%	17%	15%
Under development			9	6

Source: SALGA 2018

Table 2 gives a more detailed overview of the municipalities that allow SSEG installations within their municipalities, either on a case-by-case basis or through an application process.

<sup>8</sup> The number of municipal electricity distributors in each province is an estimate by SALGA based on the 165 distribution licences issued to municipalities by NERSA and the municipal mergers that have occurred over time.

**Table 2: List of municipalities allowing SSEG to connect to the grid**

Province	Municipality	Province	Municipality
Eastern Cape	Buffalo City Metropolitan Municipality	Western Cape	Beaufort West Local Municipality
	Kouga Local Municipality		Bergrivier Municipality
	Nelson Mandela Bay Municipality		Breede Valley Local Municipality
Free State	Mangaung Metropolitan Municipality		Cape Agulhas Local Municipality
Gauteng	City of Johannesburg		City of Cape Town
	City of Tshwane		Cederberg Municipality
	Ekurhuleni Metropolitan Municipality		Drakenstein Municipality
	Midvaal Local Municipality		George Local Municipality
KwaZulu-Natal	Ethekwini Municipality		Hessequa Local Municipality
Limpopo	Ephraim Mogale Local Municipality		Kannaland Municipality
	Polokwane Municipality		Knysna Municipality
	Mogalakwena Local Municipality		Laingsburg Municipality
Mpumalanga	Govan Mbeki Municipality		Langeberg Municipality
	Steve Tshwete Local Municipality		Mossel Bay Municipality
Northern Cape	Dawid Kruiper Municipality		Oudtshoorn Municipality
	Gamagara Local Municipality		Overstrand Municipality
	Sol Plaatje Municipality		Prince Albert Local Municipality
North West	City of Matlosana		Saldanha Bay Municipality
			Stellenbosch Municipality
			Swartland Municipality
			Theewaterskloof Local Municipality
		Witzenburg Municipality	

Source: SALGA 2018

## SSEG tariffs

There is a huge range of different tariffs across this space, and while the average tariff is high enough to seem like there should be an easy business case, it is not a true reflection of the market. The feed-in tariff for PV is significantly lower than consumption tariffs, and as such the size of systems is determined by the consumption of the off-taker, i.e. how much energy the off-taker can self-consume. This means that higher consumption customers can build larger systems and enjoy lower system costs. However, larger consumption users are generally on tariffs with lower energy charges and higher demand charges, which can dilute the business case for embedded generation.

## Tariff certainty

There is no guarantee on the structure of consumption tariffs from year to year. It is not uncommon for municipalities to force customers to change tariff types or discontinue a tariff. For example, large power users are slowly being forced to move to time-of-use tariffs. This means that while there is currently a business case for PV at a PPA of R1.10/kWh for a customer on a tariff with a charge of R1.20/kWh, switching to a time-of-use tariff means that while the customer's average tariff will not change, the value of energy in daylight hours is significantly reduced. Municipalities are moving tariffs to be more cost reflective, with the bulk of their costs coming in the form of energy purchases from Eskom. For this reason, long-term large-scale uptake of PV needs to compete with Eskom's wholesale tariffs.

### 2.3.4. Innovative finance facilitating the right type of finance into the sector

The growth of the South African energy services market is aided by 'green' energy finance offerings that facilitate the right type of financing into the energy sector. A number of exciting finance mechanisms are being tested in the market. This reports focuses on three:

#### Property Assessed Clean Energy (PACE)

According to PACENation<sup>9</sup>, PACE is a financing mechanism that enables low-cost, long-term funding for energy efficiency, renewable energy, and water conservation (resource efficiency)

projects installed by ESCOs on properties where rates are collected by their respective municipalities.

There are a few key elements of a successful PACE programme:

- It is voluntary for all parties involved.
- It can cover 100% of a project's hard and soft costs<sup>10</sup>.
- It provides long financing terms of up to 20 years, which makes it especially viable for the commercial sector.
- It can be combined with utility-scale municipal and government incentive programmes.
- The installed system is permanently affixed to a property.
- It can be repaid through the "special assessment" on the rates account and collected by the municipality of the PACE entity.

As explained in **Figure 8**, the PACE entity provides financing to the energy services company or installers who want to install resource-efficient technology on property. Once the project's feasibility has been assessed by the PACE entity, the project is then financed.

Municipalities perform their rate collection services for a small administration fee, which includes a 'special rate/tax' on the property's rates bill. This is used to re-pay the PACE entity for the installation. This 'special assessment' is linked to the property (irrespective of its owner).

If there is a default on payments, the municipality responds in much the same way as when other rates are overdue. The current or future owner will be liable to pay the overdue amount. The building owners are only liable to pay the rates for as long as they are the owners. However, they must meet the criteria set out by the PACE entity when they first approach or is approached by the ESCO that installs the service. Future potential owners must agree to the 'special rate' on the rates bill and agree to continue to pay this before they may own the building.

<sup>9</sup> <https://pacenation.us/> – A movement of people and organisations who are joined in their support for PACE financing

<sup>10</sup> Hard costs are infrastructure construction costs. Soft costs are all other costs that are not directly related to infrastructure and construction costs, such as services, legal, and administration costs.

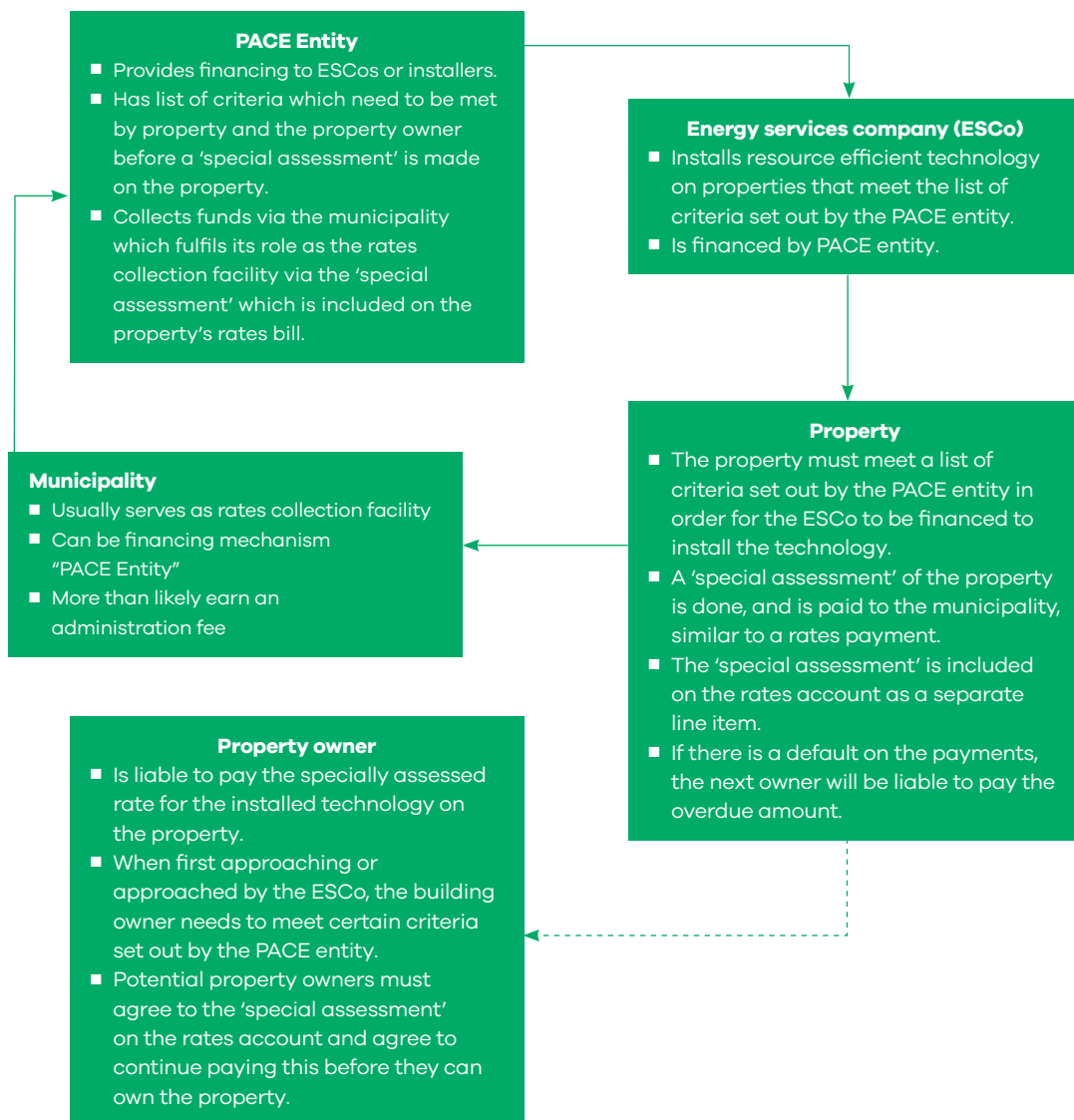

**Figure 8: PACE financing mechanism**

PACE is an international initiative; however, local programmes are being explored and tailored to meet regional market needs. Regardless of the model, there are several items that hold true for every PACE programme.

Property owners have reacted favourably to PACE internationally because investors can fund projects with no out-of-pocket costs. Since PACE

financing terms extend to 20 years, it is possible to undertake deep, comprehensive retrofits that have meaningful energy savings and a significant impact on the bottom line. The annual energy savings for a PACE project usually exceeds the annual assessment payment, so property owners are immediately cash-flow positive. It would be premature to calculate a potential market size as we are only beginning to investigate this model in



**The annual energy savings for a PACE project usually exceed the annual assessment payment, so property owners are immediately cash-flow positive.**

South Africa. The only numbers available are from an international context, different to our own.

### **Commercial banks**

Financing for SSEG, specifically rooftop solar PV, is underpinned by thousands of small contracts with consumers. Traditionally, commercial banks have favoured big solar/wind farms because they are generally based on contracts with investment-grade utilities and international companies. Only in the past 12 months have the majority of the commercial banks started to provide tailored mechanisms for rooftop solar PV investments.

Commercial and residential debt largely remains closely tied to strong individual credit scores and existing bank-customer relations. However, in 2017, the big five banks in South Africa started to focus on rooftop PV's unique financing needs, providing more targeted, patient, and affordable finance packages for commercial and residential solar PV. The inclusion of the commercial banking sector may reduce some opportunities for less traditional investors such as equity funds; however, it will unlock the SSEG opportunity for some end users and installers, EPCs, and ESCOs by providing accessible and affordable financing<sup>11</sup>.

Banks' offerings include mechanisms that cover 70%-100% of capital costs with a five- to ten-year loan repayment. However, by making use of pre-selected engineering, procurement and construction contractors (EPC) and meritorious energy audits, banks ensure that financed projects are designed so that the customer's savings generated from the solar installation are greater than the loan repayments. This results in a positive cash flow impact.

Commercial banks are understandably risk averse, seeking high returns on their investments. The fact that they see this market as a meaningful opportunity, and have designed

specific funding mechanisms for SSEG systems, is indicative of the reduced risk in the market as well as the potential financial returns available in the market.

### **Pay As You Save® (PAYS®)**

PAYS is an inclusive financing solution that allows all utility customers to access cost-effective energy efficiency upgrades and distributed renewable energy assets regardless of income, credit history, or renter status (The Lab 2018). This is particularly important for financing programmes that aim to serve market segments that are hard to reach. Of the three mechanisms listed, this is the least developed in South Africa. Future reports will detail the development of this financial mechanism.

### **2.3.5. Accreditation bodies are assuring the technical competence of installers**

Ensuring the safety and technical compliance of energy services installers and installations presents the market with a reduced risk profile. There are two certification bodies currently active in the South African PV industry, the PV GreenCard and the P4 Platform. It is expected that installer certification will inspire investor confidence, obtain the buy-in of industry colleagues, and put the solar PV system owner and potential future owners at ease.

### **PV GreenCard**

The South African Photovoltaic Industry Association (SAPVIA) launched the PV GreenCard accreditation programme in 2017 to promote high-quality solar PV installations (PV GreenCard 2018). Essentially, it is an as-built report for the system owner, and a safety certification, quality assurance standard, and training programme for the installer. The PV GreenCard is issued *per installation*, and does not ultimately qualify any installer. That is, the installer is able to use the PV GreenCard to declare compliance with relevant standards as well as safety guidelines for the given PV installation. This will inspire investor confidence and put the solar PV system owner and potential owners at ease.

SAPVIA's PV GreenCard database lists EPCs registered with the Department of Labour that have safely completed installations at well-known, reputable companies that have complied with all municipal requirements. To be issued with

<sup>11</sup> Most commercial banks do not offer standalone services.

a PV GreenCard, the installer must comply with all the applicable standards and safety guidelines 'from the system design, to the choice of components, to installation and grid connection and final commissioning' (PV GreenCard 2018).

### P4 Platform

PQRS (Power Quality and Renewable Services) developed the PQRS PV Performer Platform (P4 Platform), a quality assurance platform, to score PV contractors in terms of risk based on performance, knowledge and best practice (as opposed to individual installations). This is done by measuring five performance metrics in as many steps, after which a performance certificate is awarded. These steps are:

- agreeing to the platform's Terms and Conditions;
- taking the online P4 PV theoretical test;
- evaluating random installations using a visual evaluation form;

- listing solar PV installations done by the organisation on the PQRS directory; and
- having the end-users' review published on the P4 Platform (PQRS 2018).

## 2.4. Key players

Figure 9 shows the ES value chain and key players in the value chain, with the roles of specific actors outlined in Table 3.

The value chain is based on the stages of a generic energy intervention, showing the types of services or products provided by key players during an energy service intervention. This represents a simplified view of the value chain. In practice, the roles of these actors often shift with relative fluidity. For example, the boundary between a project developer, Engineering, Procurement and Construction (EPC) company, and installer is often blurred, with players taking on different roles depending on the size, cost, ease of implementation, or other project-specific factors.

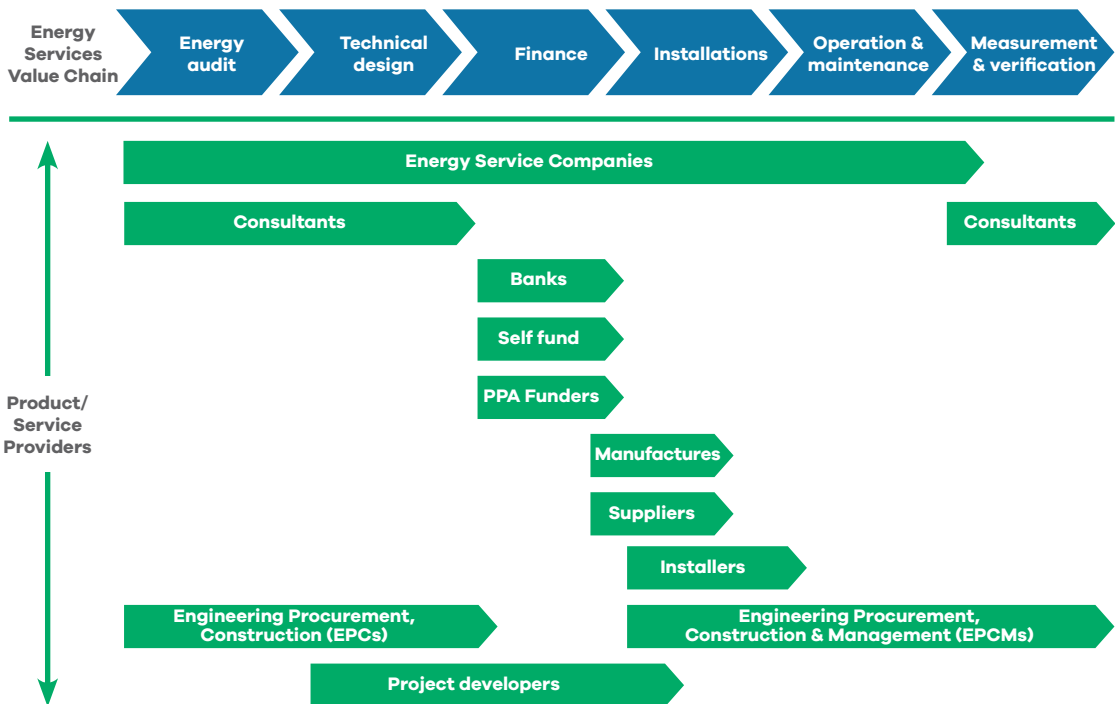

Figure 9: ES market value chain

**Table 3: Roles of key players in the ES value chain**

Key player	Role
<b>Energy services companies (ESCOs)</b>	ESCOs are active across the whole value chain, aside from measuring and validation, as independent consultants perform this function. There are two generic ESCOs-type energy contract models: <ul style="list-style-type: none"> <li>■ <b>Energy supply contracting (ESC)</b>, which delivers units of energy.</li> <li>■ <b>Energy performance contracting</b>, which provides energy savings determined by comparison to an established and agreed upon baseline.</li> </ul>
<b>Consultants</b>	Consultants include energy auditors, planning engineers, certified measurement and verification personnel (CMVP), accountants, and lawyers.
<b>Financiers</b>	Financiers provide funding and financing mechanisms to realise projects. <ul style="list-style-type: none"> <li>■ <b>Project finance</b> – commercial banks (commercial and asset funding), self-funded individuals (with cash reserves) and PPA financiers (such as private equity funds, debt facilities).</li> <li>■ <b>Funding for ESCOs</b> (not detailed in diagram) – commercial banks, private equity funds, corporate foundations, private and family foundations, and venture capitalists.</li> </ul>
<b>Manufacturers and suppliers</b>	Manufacturers and suppliers include technology suppliers or original equipment manufacturers (OEMs). They manufacture and supply equipment, and form part of typical energy efficiency or supply interventions.
<b>Installers</b>	Most energy service companies, EPCs and project developers make use of specialised installers for both energy efficiency and SSEG (technology specific).
<b>Engineering, procurement and construction (EPC) company</b>	EPCs design interventions, procure and install tailored turnkey energy efficiency and/or renewable energy solutions.
<b>EPCM (Engineering, Procurement, Construction Management)</b>	Under an EPCM contract, the owner maintains more control of the project. The contractor manages the construction project, but only under the direction of the owner. With an EPCM contract, the owner is responsible for hiring suppliers, construction workers and other contractors, and the EPCM contractor will manage these contractors.
<b>Project developers</b>	Project developers handle tasks that focus on moving the project along toward successful completion. In the ES value chain, they play more of a business development role as they focus on, for example, project design and procurement, but make use of specialised installers.

As with much of South Africa’s green economy, the ES value chain is dominated by small- and medium-sized enterprises (SMEs). Confidence in new leadership and the ensuing policy recommendations have inspired increased local and foreign investment into the market. As the market continues to develop, disruption will be a feature of this nascent economic sector, more so than traditionalism.

Adapting to this type of rapid growth is easier for SMEs as they are not hampered by pre-existing corporate structures and sunk investment. That said, their growth could be stifled by their inability to scale up or down fast enough to take advantage of existing opportunities.

## 2.5. Governance

### 2.5.1. National government

A number of government departments and institutions guide the development of the ES sector:

- **The Department of Energy (DoE)** is the custodian of all energy policies and energy security in South Africa.
- **The Department of Trade and Industry (dti)** is responsible for commercial policy and industrial policy.
- **The Department of Public Enterprises (DPE)** is responsible for the country's energy infrastructure, primarily through its responsibility over state-owned entities such as Eskom.
- **Eskom** is the state-owned energy utility. It owns most of the electricity generation, transmission and distribution infrastructure. As such, it is an essential player in the electricity sector, especially as a delivery vehicle for numerous government programmes.
- **South African National Energy Development Institute (SANEDI)** is responsible for achieving the objectives of the National Energy Efficiency Strategy (NEES), the main strategy guiding the uptake of energy efficiency projects in South Africa. SANEDI's primary function is to direct, monitor and conduct applied-energy research, development, demonstration and deployment. It also has to undertake specific measures to promote the uptake of Green Energy and Energy Efficiency in South Africa.
- **The National Energy Regulator of South Africa (NERSA)** regulates the electricity sector, with the DoE as the custodian department. NERSA's main energy services-related responsibilities are:
  - licensing and registrations;
  - pricing and tariffs;
  - promoting competition; and
  - compliance monitoring and dispute resolution.

### 2.5.2. Local government

- **Local (municipal) government** is the arm of government closest to the end users. Municipalities are responsible for a large portion of electricity distribution in the country.

### 2.5.3. Industry bodies

- **South African Photovoltaic Industry Association (SAPVIA)** is a not-for-profit organisation that

represents the solar PV industry in South Africa.

It aims to ensure that solar PV is the generation technology of choice in South Africa and the rest of Sub-Saharan Africa, in support of the country's socio-economic development targets.

- **South African Wind Energy Association (SAWEA)** is a not-for-profit, member-driven association that aims to enable a commercial wind power industry in South Africa.

## 2.6. Total available ES market size

Using the total available market for solar rooftop PV systems installed in the country, energy storage, and capital leveraged in energy efficiency interventions implemented by South African energy users, **South Africa's total available ES market is valued at ~R125 billion by 2035.**

The total available market is the total untapped demand for a product or service in the ES market. The total available market size detailed in this MIR represents an estimate of the ES market, based on only three of the currently dominant ES market components – solar PV<sup>12</sup>, energy storage, and energy efficiency. The estimate does not take into account smaller technology market segments that are also part of this market sector, such as small-scale wind energy, waste-to-energy, and diesel generators.

### 2.6.1. Rooftop solar photovoltaic (PV) market size

One of the major contributors to growth in the ES market has been the demand for rooftop solar PV. By 2016/17, there was a total of 90 260<sup>13</sup> verified (~180 MW<sub>p</sub>) installed solar PV rooftop systems throughout South Africa, valued at R2.7 billion (PQRS 2017a). This number did not include the 48 067 systems which were identified, but not verified. Estimations based on actual solar PV panel sales figures suggested that installed capacity in 2017 could be closer to ~430 MW<sub>p</sub>, based on the PQRS (2017b) methodology.

In 2018, the installation rate of the past few years (from 2016 onwards) was maintained. Between 150 MW<sub>p</sub> and 200 MW<sub>p</sub> of rooftop solar PV was installed in South Africa in the last 12 months, taking the estimated total installed capacity to ~600 MW<sub>p</sub>. Although residential systems (4-10 kW<sub>p</sub>) make up the majority of installed systems,

<sup>12</sup> Currently, the South African small-scale embedded generation (SSEG) market is dominated by rooftop solar PV given the competitive price, technical maturity, and ease of implementation of this technology.

<sup>13</sup> Installations are considered 'verified' if an inspection has been done and a commission date has been specified.

**Installed capacity could reach 7.5 GW by 2035, a total available market of R75 billion.**

the capacity gains are sustained by larger installations of between 450 kW<sub>p</sub> and 1 MW. The total annual available market could continue to grow at this rate to a saturation point of ~500 MW<sub>p</sub> installed per year, reaching a total of 7.5 GW of installed capacity by 2035. **At a cost of R10/W<sub>p</sub>, this installed capacity growth represents a total available market of R5 billion a year and a total available market of R75 billion by 2035.** The installation of an additional 500 MW<sub>p</sub> in one year translates to the potential creation of ~1 250 jobs.

The commercial and industrial (C&I) sectors in South Africa continue to present the largest near-term opportunity for installations, with ~75% of the total verified systems installed in that sector (see Figure 10). The reason for this is two-fold – affordability and need. The C&I sector generally incurs higher electricity costs for being the highest energy users. The sector also has the best use profiles and stands to gain considerably from installing rooftop solar PV through the various contracting models available to them. Businesses in this sector also often operate from large premises with large roof spaces, which are attractive from an installation point of view.

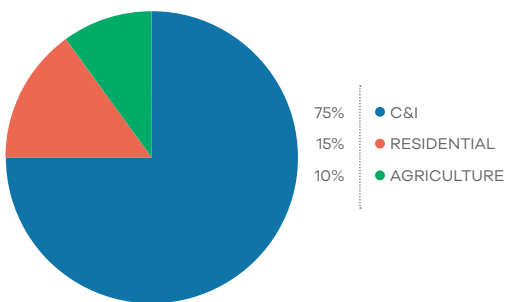

**Figure 10: Distribution of solar PV installations across end-user segments in South Africa**

Source: PQRS (2017a)

### 2.6.2. Energy storage market size

The South African market for energy storage is in its infancy. Beyond a handful of private customers that have invested in battery

technology to ensure energy security for their operations, the price is not yet right for behind-the-meter application. However, energy storage is expected to become the keystone of the future SSEG market.

Currently the potential market is made up of mostly grid management and resource adequacy applications:

- **R15 billion to R30 billion by 2030** (GreenCape estimates), based on replacement of at least 50% of South Africa’s gas fired power (~6GW-12GW) as a resource adequacy application.
- Additional daily balanced energy storage of 2 GW, private sector/customer side investment in demand-side management, and backup power with a market value of **R5 billion by 2035**.

**The market for battery storage is estimated to be R15 billion to R30 billion by 2030 for resource adequacy applications, and R5 billion by 2035 for demand-side management and backup power.**

Globally, the demand for energy services (energy efficiency and embedded generation) is growing. Developments such as battery storage options are emerging as the latest trends that will drastically influence the energy services market. Similar to the growth in the renewable energy market, growth in this space is driven by rising electricity costs, increased financial returns from storage investments, and growing awareness of the impact of carbon emissions. The annual turnover for the global market is expected to reach R200 billion by 2024 (Navigant Research 2017)

These trends are reflected in the South African energy services market, but the applications and related value streams of storage are only just beginning to be understood locally. Figure 11 shows the eight storage applications most likely to gain traction in South Africa before 2035. The most attractive ones currently are increased resource adequacy, grid management (voltage and frequency), and capital expense deferral for utilities, with some applications for PV self-consumption for high-end customers and backup power.

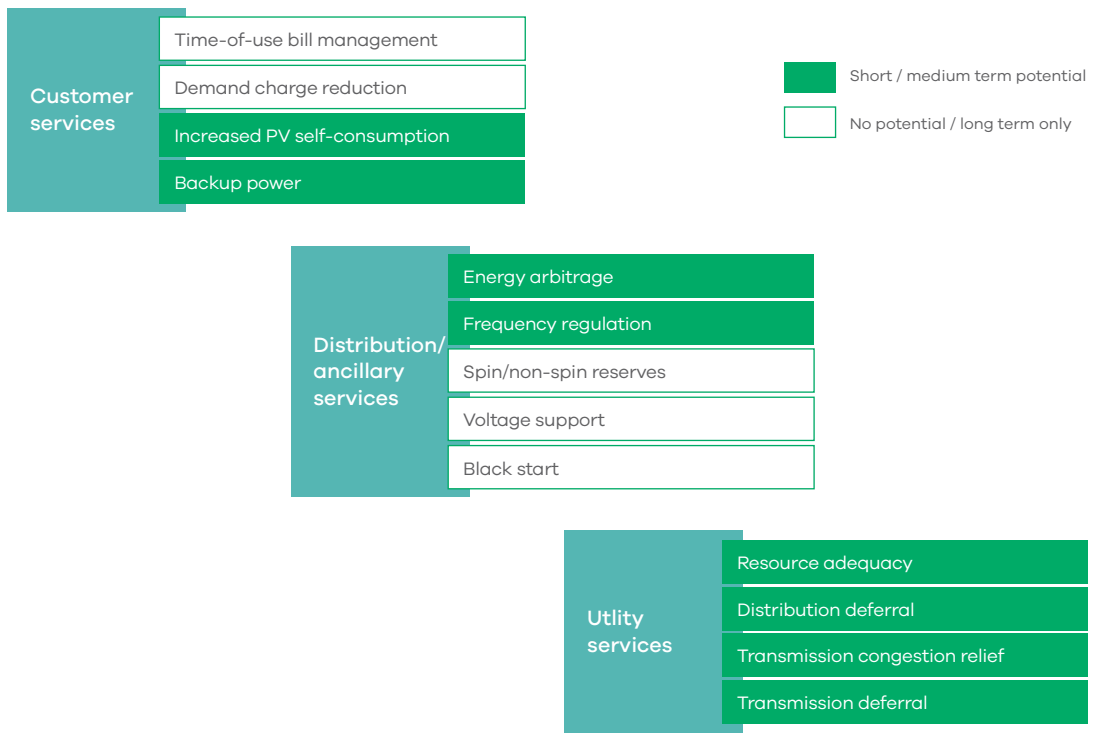

**Figure 11: Eight services are applicable in the South African energy storage context**

**Replacing gas with energy storage:** From a storage perspective, Eskom has a monopoly on the value chain up to behind-the-meter applications. In late 2018, Eskom revealed that it would put on hold the development of its 100 MW Kiwano CSP project in the Northern Cape in favour of a battery storage development project. This occurred at the same time that the Minister of Energy indicated that IRP 2018 allocation for gas could be replaced with any form of energy storage that could provide similar services. As noted, this could represent a market of between R15 billion and R30 billion by 2030 (GreenCape estimates), based on the replacement of at least 50% of South Africa's gas fired power (+-6GW) as a resource adequacy application.

**Grid management:** Municipalities may also be interested in storage as a means to take advantage of electricity price arbitrage<sup>14</sup> in the peak vs off-peak tariffs offered to them by Eskom. This could represent a need of almost 2 GW of additional daily balanced energy storage, and private sector/customer side investment in demand-side management and backup power with a market value of R5 billion by 2035.

**Private customer use:** As the price of energy storage behind the meter continues to drop, the business case for end-use customers will improve. The further down the value chain storage is located, the more value is likely to be extracted from the full range of applications. In particular, behind-the-meter/customer located storage is best suited to provide the most important service: backup power.

<sup>14</sup> Arbitrage refers to the use of stored capacity (stored during periods of low electricity tariffs) and then used during peak tariff times (thereby avoiding some of the high peak tariffs)

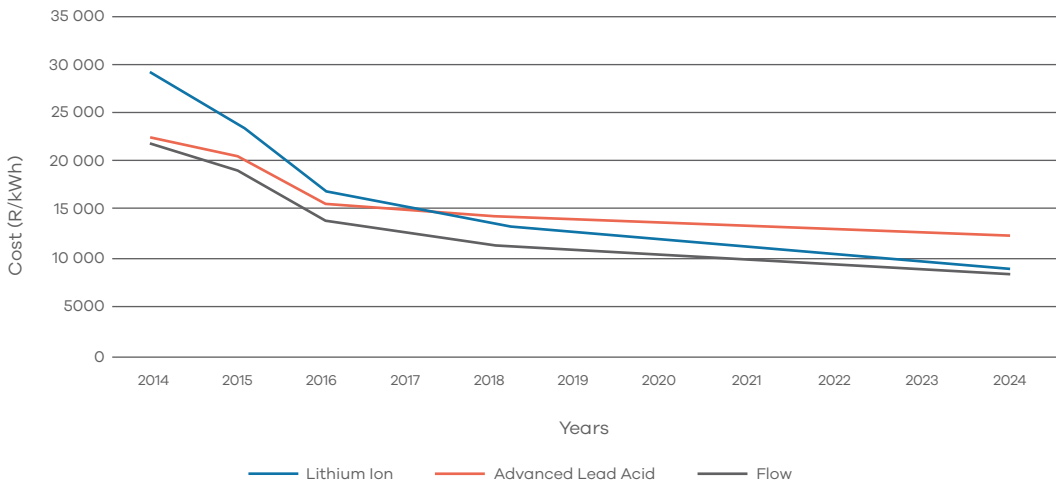

**Figure 12: Behind-the-Meter energy storage cost trajectory per technology 2014-24**

Source: Adapted from IFC (2017a)

Energy storage can generate much more value when multiple, stacked services are provided by the same device or fleet of devices. Current behind-the-meter business models typically leave significant value on the table. Currently, most systems are deployed for one of three single applications: demand charge reduction, backup power, or increasing self-consumption of solar PV power. These systems are often used for less than half their useful lifetime. Dispatching batteries for a primary application and then re-dispatching them to provide multiple, stacked services creates additional value for all electricity system stakeholders. Creating the right electricity market structure and conditions is crucial to enable this approach; thereby unlocking the energy storage market while creating viable and sustainable business cases.

A number of crosscutting barriers prevent energy storage from providing numerous services to the electricity grid in South Africa:

- **Lack of rules and regulations** that would place behind-the-meter energy storage on an equal playing field with large central generators.
- **Wholesale and retail electricity tariffs are not cost reflective.** Not all customers are on time-of-use tariffs, and the peak/off-peak differential for those who are, does not accurately reflect the cost of generation, transmission, and distribution.
- There are **no regulations defining the role played by storage** at any point in the value chain, and storage is not accounted for in the national Integrated Resource Plan.

### 2.6.3. Energy efficiency market size

Energy efficiency measures that often cost very little can save companies significant amounts of money. This is reflected in the findings of the National Business Initiative (NBI) through its now discontinued Private Sector Energy Efficiency (PSEE) programme. The programme identified and facilitated the implementation of a sizeable set of energy efficiency opportunities in the private commercial sector between 2013 and 2015, as shown in [Table 4](#) (NBI 2016).

**Table 4: Total energy savings opportunities and capital leveraged for small and large businesses identified by the PSEE programme**

Source: Adapted from NBI (2016)

Type	Identified	Implemented	Remaining opportunity	Percentage still to be realised
Number of sites	1103	336	767	70%
Number of opportunities	6 921	796	6 125	88%
Annual energy savings	2 087 GWh	129 GWh	1 958 GWh	94%
Lifetime energy savings	21 896 GWh	646 GWh	21 250 GWh	97%
Lifetime carbon savings	449 MTCO <sub>2</sub> e	17 MTCO <sub>2</sub> e	432 MTCO <sub>2</sub> e	96%
Capital leveraged	R3.5 billion	R69.5 million	R3.4 billion	98%
Average payback of opportunities	2.3 years	0.9 years	–	–
Annual energy usage	5 861 GWh	362 GWh	–	–

The current capital leveraged in the PSEE program is R69.5 million, which has resulted in 646 GWh of lifetime energy savings (R0.10/kWh). Given that the data in [Table 4](#) represents a sample of energy end-users and the number of opportunities within the sample that have gone untapped, there is a significant opportunity for further energy efficiency interventions across a wider array of economic sectors and businesses – suggesting substantial market opportunities for ES market players.

Compared to the annual electricity consumption in South Africa, the 2 087 GWh savings identified through the PSEE represents only a small fraction of the possible energy efficiency market. The International Energy Agency (IEA) (2017) calculates South Africa's annual energy use to be ~868 TWh, with electricity making up ~200 TWh of this total. Industry is the largest consumer of energy, with direct use of coal and coal-based electricity being the major energy sources, as shown in [Figure 13](#) (IEA 2017).



South African 2015 energy use (GWh)

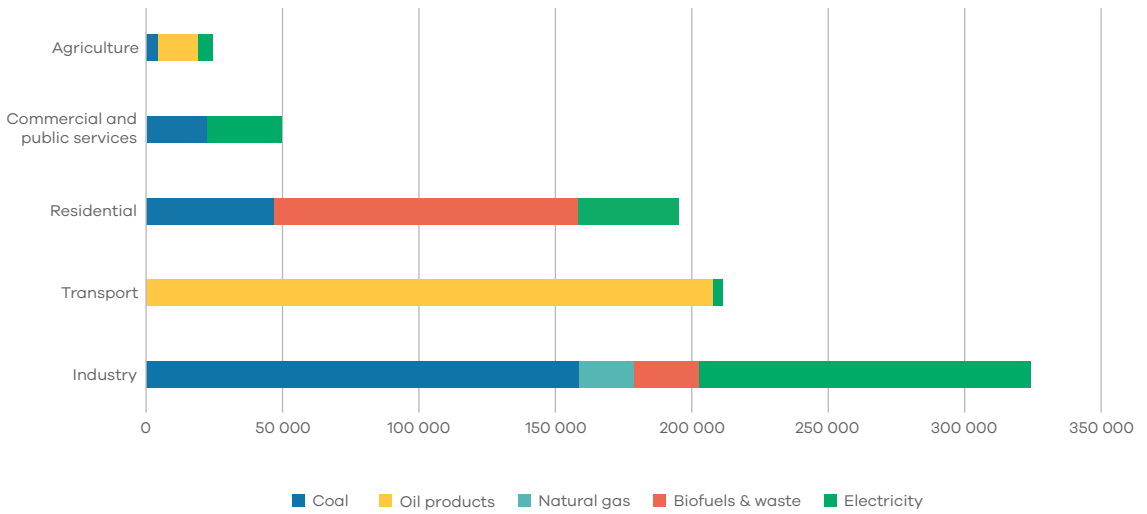

Figure 13: 2015 energy consumption in South Africa (GWh)

Source: International Energy Agency (2017)

If it is conservatively assumed that annual energy savings of 15% of total energy consumption is possible (the PSEE programme findings show 20%-35%), then potential energy efficiency savings could be as much as 30 TWh.

**At a conservative rate of R0.10/kWh, the estimated annual total available market is R3 billion. GreenCape's most recent market evaluation suggests the total available market size could reach R25 billion by 2035.**



# 3

## Legislation, regulation and policy

**A number of acts, regulations and policies guide the development of the electricity sector, with the main guiding document being the Integrated Resource Plan (IRP) 2018.**

### 3.1. Legislation and regulation

**Electricity Regulation Act 4 of 2006** as amended by the **Electricity Regulation Amendment Act 28 of 2007 (ERA)**: These regulations guide the issuance of licences for generators and transmitters, wheelers and distributors of electricity. **On 10 November 2017, amendments were made to Schedule 2 of the ERA**, which regulates categories of generation facilities and resellers who would be exempt from the licensing requirement. For investors, this is a key step towards regulatory certainty. Effectively, the Department of Energy (DoE), through the ERA, requires that all generation must be registered with NERSA and that a generation licence must be obtained, *except* in the following scenarios:

■ **Through exemptions**, applicable in the following cases:

- If the generation facility is < 1 MW and connected to the national grid and supplies a single customer (irrespective of wheeling status); the generator or single customer has entered into a connection agreement with, or obtained approval from, the relevant distribution licence holder; and at the date of this agreement, or approval, the Minister of Energy has not published a notice in the Government Gazette stating that the installed capacity (MW) allocated in the IRP for embedded generation (EG) of this nature has been reached.
- If the generation facility is < 1 MW and not grid-connected and supplies a single

customer who is the owner of the facility, a relative of the generator or owner of the facility, or a customer for consumption on the same property as the generation facility.

- If the generation facility is < 1 MW and is off-grid and not having an interconnection agreement<sup>15</sup> and is operated solely to supply electricity to the owner, relatives of the owner or generator or to a customer for consumption on the same property as the generation facility.
- If the generation facility is used for test or demonstration purposes only and this electricity is not sold, and the facility will not be in operation for more than 36 months.
- If the generation facility produces electricity from a co-product, by-product, waste product or residual product of an industrial process and supplies it to a single customer who is the owner of the facility, a relative of the generator or owner of the facility or to a customer for consumption on the same property as the generation facility.
- Back-up or standby generation in the event of and for the duration of the electricity supply interruption.
- The continued operation of existing generation facilities which were exempt from requiring a licence prior to the amendment of Schedule 2 of the ERA, or were in operation before then, and within

<sup>15</sup> An interconnection agreement is an agreement between the generator and the local electricity distribution licensee.

three months of the commencement of Schedule 2 has declared non-compliance with the Schedule to NERSA and signed an agreement to comply within a time frame as specified by NERSA.

- Distribution facilities connected to generation facilities, which are used exclusively for the wheeling of electricity from the facility to the customer (off-grid) or to the point of connection (grid-connected).
- Electricity resellers where the tariff or price charged by the reseller to customers is not more than the price charged by a registered licensee; and there is a service delivery agreement with the relevant distribution licence holder; and NERSA has approved this service delivery agreement.

**National Energy Act 34 of 2008:** The National Energy Act was promulgated to ensure that diverse energy resources are available to the South African economy in sustainable quantities and at affordable prices in support of economic growth and poverty alleviation. The Act takes into account environmental management requirements and interactions among economic sectors. It provides for the development of the Integrated Energy Plan (IEP) and the formation of the South African National Energy Development Institute (SANEDI).

**National Energy Efficiency Strategy (NEES) 2005, 2008, post 2015:** The aim of the original NEES (2005) was 'to explore the potential for improved energy utilisation through reducing the nation's energy intensity (thus reducing greenhouse gas emissions), and decoupling economic growth from energy demand' (Modise 2013) by achieving overall sectoral energy intensity reduction targets of 12% by 2015. In 2008 and 2011, the NEES was reviewed to discuss its scope and elements. The Post-2015 National Energy Efficiency Strategy will be based on 25 policy recommendations within seven priority areas developed by the International Energy Agency (IEA 2014):

- cross-sectoral;
- buildings;
- appliances and equipment;
- lighting;
- transport;
- industry; and
- energy utilities.

This updated strategy document builds on the original NEES. It is framed to complement the policies and strategies put forward by other national departments. The draft document was published for public comment in December 2016 but has not yet been finalised.

**Energy mandatory reporting 2015:** It is mandatory for all energy users consuming above 180 TJ per year to submit their energy consumption data to the DoE. Companies using 400 TJ or more per year are required to submit a detailed energy management plan. The reporting requirement is applicable to all forms of energy.

**Carbon taxes 2017:** The Draft Carbon Tax Bill was tabled in December 2017 and has been put out for public comment. It was envisaged that a carbon tax proposed by the National Treasury would be implemented, commencing in 2017 at a rate of R120 per tonne of carbon dioxide equivalent (tCO<sub>2</sub>e) on direct emissions, increasing by less than 8% (CPI+2%) per year until 2020. With exemptions, it means that the actual payment would range between R6 and R48 per tonne. National Treasury has proposed a 'polluter pays principle' to the tax, but it should also reward those who work towards cleaning up the environment, and promote our transition towards a low carbon economy, creating new jobs and skills at the same time. It is expected that the Carbon Tax Bill will be passed later in 2018. The original date for implementation of the carbon tax has been postponed from 1 January to 1 June 2019<sup>16</sup>. This would especially affect businesses with high fuel and electricity consumption. The impact of this tax on the uptake of solar and other renewable forms of energy will be interesting to witness.

## 3.2. Policy

**White Paper on Energy Policy of 1998:** This paper identifies the need for energy demand-side management and the promotion of energy efficiency in South Africa. Appropriate and supportive energy policies are required to attain the energy efficiency and conservation targets embodied in the IRP framework. The white paper effectively supports the national Department of Energy's (DoE) mandate to ensure secure and sustainable provision of energy for socio-economic development by suggesting that it pursue energy efficiency programmes as one of the lowest cost options for reducing energy consumption.

<sup>16</sup> For more information on national documents for public comment regarding carbon taxes: <https://goo.gl/hqNuay>



**Integrated Energy Plan (IEP) 2010:** The Integrated Resource Plan (IRP) is developed in the context of the Integrated Energy Plan (IEP), which guides the country's broader energy needs. The IEP was also developed in terms of the National Energy Act of 2008. This plan seeks to ensure diversity of energy supply as well as security by combining the objectives of the country's climate change, energy supply, and energy demand plans and aspirations. The IEP was released for public comment between November 2016 and March 2017, and an updated energy plan is yet to be published at the time of writing. The primary difference between the IRP and IEP is that the IRP's focus is on electricity, its supply, and NERSA's ability to grant licences, while the IEP considers the whole energy sector and the implication of different prices.

**Integrated Resource Plan (IRP) 2018:** First promulgated in 2011, the IRP guides electricity provision in South Africa. Its custodian is the DoE. The IRP, a living document that the DoE is to update every two years, provides an overall plan indicating the quantities of various electricity sources to meet the country's electricity demand in the next 20 years (the typical planning horizon). The IRP provides guidance for future energy infrastructure investments and thus largely determines the country's generation mix. A draft IRP 2018 was released for comment in August 2018.

	Coal	Nuclear	Hydro	Storage	PV	Wind	CSP	Gas/ Diesel	Other (cogen, biomass, landfill)	Distributed Generation
Current	37149	1860	2100	2912	1474	1980	300	3830	499	
2019	2155					244	300			Allocation to the extent of the short term capacity and energy gap
2020	1433				114	300				
2021	1433				300	818				
2022	711			513	400	1000	1600			
2023	750				1000	1600			500	
2024		1860				1600		1000	500	
2025					1000	1600			500	
2026						1600			500	
2027	750					1600		2000	500	
2028					1000	1600			500	
2029				1575	1000	1600			500	
2030			2500		1000	1600			500	
Total Installed Capacity by 2030 (MW)	44381	3720	4600	5000	8288	17742	600	6830	499	4000

Source: Adapted from DoE (2018)

- Installed capacity
- Committed/Already contracted
- New capacity
- Extension of Koeberg plant life
- Distributed generation capacity for own use

**Figure 14: IRP 2018 Allocations**

Figure 14 shows the allocations from 2018 to 2030 for each type of energy generation stated in the draft IRP 2018. In terms of updates, the key assumptions that have changed are those of Eskom's plant performance availability; a 30% reduction in demand from the IRP 2010's expectations; and the lower costs of technology being used.

The draft IRP 2018 has been designed with an extended vision to 2030, optimising the supply demand based on a least cost path. In terms of embedded generation, this draft update has an open allocation for the first four years and 500 MW thereafter for embedded generation for own use of

between 1 MW to 10 MW, starting in 2019. GreenCape interprets this to also include installations under 1 MW. Our understanding is that these installations (<1 MW) are not specifically listed because 1) this market makes up a fairly small percentage of the total; and 2) there is no need to obtain generation licences for these systems with NERSA (see Section 3.1). In addition, while it seems as though the allocation for embedded generation is flat, there has been a commitment from government to update these numbers on a yearly basis. When we reach a *real* market cap, there will be ministerial determinations for this. However, the finalised IRP 2018 will confirm this.



# 4

## Emerging opportunities, drivers and barriers

**The evolving South African energy landscape creates opportunities for investors, financiers, project developers, component manufacturers and suppliers in embedded generation and energy efficiency markets.**

The following emerging opportunities have been identified through engagement with an array of ES and green economy stakeholders. Whereas the drivers for these emerging opportunities are explored in more detail in [Section 2.3](#), each opportunity is outlined in greater detail in the sub-sections below:

### Embedded generation

- **Commercial off-the-shelf systems:** These are systems that are developed to meet a growing typology, and are not bespoke. Ready-made options offer reduced design and engineering costs, decreasing the overall cost of the system, and attracting better financing options. This opportunity is for investors, ESCOs, EPCs, and EPCMs.
- **Rooftop PV system bundling:** This opportunity involves aggregating smaller rooftop PV projects to reach a scale where they become attractive to larger investors by reducing transaction costs and spreading the risk across the new bundle. This opportunity is for investors and project developers.
- **Secondary market for PV components:** With significant technology developments and price reductions, some projects may reach the end of their value to a specific set of customers before the end of their useful life. This opens up a market for those customers who could not previously afford a new system to capitalise on a used one. This opportunity is for investors, EPCs and resellers.

### Energy efficiency

- **Modernisation:** The retrofitting of South Africa's large stock of existing buildings is expected to become the largest sector within

the green building industry by 2020. This opportunity is for ESCOs specialising in energy efficiency measures like lighting, HVAC, and smart metering.

### 4.1. Commercial off-the-shelf systems

Commercial off-the-shelf or commercially available off-the-shelf (COTS) PV systems are packaged solutions which a customer can purchase as is, i.e. the system is not custom made. COTS offer significant cost savings on design by producing pre-packaged systems which can then be easily adapted to satisfy specific needs.

By offering COTS PV systems with generic design, technology and contracts (PPAs) to make them replicable, ESCOs, EPCs and EPCMs can reduce working capital, lower electrical and hardware labour costs, shorten the time it takes to install, and attract better financiers and financing options. At present, design costs make up ~15% of each system's total cost, as shown in [Figure 15](#)

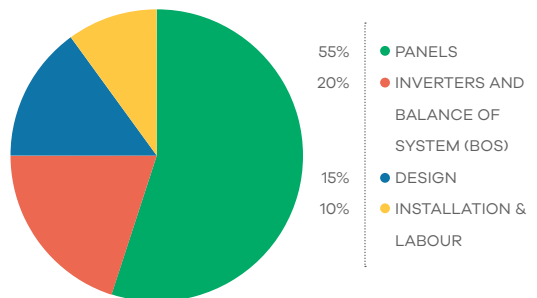

**Figure 15: Average cost breakdown of PV system components**

As electricity prices go up, ESCOs can put these standardised projects on many roofs at a slightly lower rate than what the municipality charges, ensuring a constant income stream. While we

are seeing lower solar rand/watt prices opening up new markets, the design and installation costs are slowing overall affordability, and thus adoption.

Drivers	Barriers
<ul style="list-style-type: none"> <li>■ <b>Removing design costs</b> significantly improves business case and can make PPA tariffs competitive.</li> </ul>	<ul style="list-style-type: none"> <li>■ <b>The differential between feed-in and self-consumed energy</b>, means that the business case is heavily affected by the user load profile.</li> </ul>
<ul style="list-style-type: none"> <li>■ <b>Packages pre-designed to match available inverters</b> increase the efficiency of the system's cost vs output, improving the business case</li> </ul>	<ul style="list-style-type: none"> <li>■ <b>Lack of low cost energy wheeling</b>, means that there is no alternative market for excess energy.</li> </ul>
	<ul style="list-style-type: none"> <li>■ <b>Business case is not sustainable</b> on feed-in tariff alone. If it were, systems could be installed regardless of load profile.</li> </ul>

## 4.2. Rooftop PV system bundling through contract standardisation

The lack of availability of affordable finance still represents a significant barrier for rooftop PV investments/projects. For directly financed projects, the risk profile and credit worthiness of the off taker (usually the owner of the system) is currently considered, rather than the value of the asset. Banks are using vehicle finance models to finance PV; thus rates are often significantly above market lending rates (13-18%). Finance is generally available for tenors of up to 10 years, i.e. significantly less than asset life.

Rooftop PV bundling is much the same as investment warehousing. It is aimed at reducing the financing cost, which can make up a significant portion of the overall system cost.

This is a basic aggregation technique to reduce transaction costs and facilitate investment. Smaller rooftop PV projects are bundled together to reach a scale where they become attractive to larger investors who, up until now, have only been interested in utility-scale RE projects. This "bundling" can either take place before projects are built, or be a refinancing driver post construction.

Once a bundled portfolio of smaller PV systems reaches a scale, transaction costs can be reduced and project, technology, and commercial risks can be spread across the portfolio. This will unlock improved market lending rates. In order to achieve this bundling effect, projects need to be designed using standard contracting models, e.g. PPAs, that can be easily compared and combined.



Drivers	Barriers
<ul style="list-style-type: none"> <li>■ The biggest driver is that <b>aggregation of systems improves the business case for larger investors</b>. By bundling, overall system costs are reduced because transaction costs per system are avoided.</li> </ul>	<ul style="list-style-type: none"> <li>■ <b>Lack of standard PPA contracts</b> means that projects are not easily bundled.</li> </ul>
<ul style="list-style-type: none"> <li>■ <b>Smaller SSEG companies are able to attract investment from financiers</b> who up until now have only been interested in utility-scale investments due to economies of scale.</li> </ul>	<ul style="list-style-type: none"> <li>■ <b>Bespoke installations currently dominate</b> and are custom developed based on the load profile of a customer. These are not easily bundled as each project needs to be investigated individually.</li> </ul>
<ul style="list-style-type: none"> <li>■ A <b>PACE programme (Section 2.3.4)</b> would <b>improve business case</b> for aggregated small PV projects.</li> </ul>	<ul style="list-style-type: none"> <li>■ <b>The differential between feed-in and self-consumed energy</b> makes creating a standard PPA contract for bundling very difficult.</li> </ul>

### 4.3. Secondary market for PV system components

The secondary market for solar PV system components represents an exciting new market niche in the energy services value chain – as investors, EPCs and ESCOs could access cheaper equipment in a market driven by cost competition.

The adage that a new car loses 20% of its value the minute it is driven off the dealer’s lot has long been held as a reason for car shoppers to consider used vehicles. The theory is that the first owner will see a big depreciation in the value of the asset, while the second owner pays a much lower price but still gets useful life out of it. The same principle is starting to be applied to the solar industry, where the secondary market is becoming a potential opportunity for resellers.

South Africa has an estimated total installed capacity of over 600 MW<sub>p</sub> in its small scale market, and more than 3 GW of large scale solar projects that span back to early 2013. With significant technology developments and price

reductions, some of these projects may soon reach the end of their value to a specific set of customers – before the end of their useful life. This means that an increasing number of customers who currently cannot afford to purchase new equipment may turn to secondary market resellers for quick delivery of old (and new) equipment, which will need to be coupled with knowledgeable installation, responsive service, and support.

Using the cost breakdown in Figure 15, if ~600 MW<sub>p</sub> of systems enter the secondary re-sale market in the next five to ten years, the secondary market for panels will be ~R5 billion, and the secondary market for inverters will be ~R2 billion.

**In the next five to ten years, the secondary market will be ~R5 billion for panels and R2 billion for inverters.**

Drivers	Barriers
<ul style="list-style-type: none"> <li>■ <b>Banks willing to take solar PV panels as collateral for providing debt finance.</b> This suggests that they see the value in the asset and the viability of a strong second-hand market.</li> </ul>	<ul style="list-style-type: none"> <li>■ <b>Rapidly falling cost of new renewable energy technologies</b> means that it might in fact be more valuable to buy a cheaper system new.</li> </ul>
<ul style="list-style-type: none"> <li>■ <b>Quality assurance certifications like the PV GreenCard and P4 Platform</b> will require non-compliant systems and components to be dismantled. While these components might not serve a use within SSEG, components like inverters can be reused elsewhere.</li> </ul>	<ul style="list-style-type: none"> <li>■ <b>The current market size for second hand systems and components is low</b> but will take off as the mentioned drivers become more robust and prominent.</li> </ul>
<ul style="list-style-type: none"> <li>■ <b>The SSEG market is driven by cost competition.</b> Cheaper second-hand equipment costs result in cheaper cost/kW<sub>p</sub>, making the overall system cost more attractive.</li> </ul>	

#### 4.4. Modernisation of buildings for energy efficiency

The South African resource efficient (green) building and construction sector presents an exciting opportunity for ESCo specialisation. The national market has grown exponentially since 2010, and is expected to be valued at R13.6 billion by 2020 (IFC 2017b). To date, more than 400 buildings have been certified by the Green Building Council in South Africa across its various categories, saving ~600 million kWh of energy per year.

New buildings only make up ~5% of total buildings in South Africa, and retrofitting of existing buildings is expected to become the largest sector within the green building industry by 2020. In the public and private sector, there are opportunities for ESCOs to provide energy efficiency retrofits such as LED lighting, HVAC optimisation, and smart metering. Shifting from new green buildings to resource efficiency retrofitting is expected because demolition and rebuilding is not a financially viable option for most owners. Besides, buildings have long lifespans and require upgrades to keep up with changing business needs and manage depleting natural resources.

Drivers	Barriers
<ul style="list-style-type: none"> <li>■ <b>Legislative and regulatory changes make the built environment more conducive to embracing resource efficiency.</b> The Post-2015 National Energy Efficiency Strategy aims for South Africa to have energy-efficient buildings by 2030. The Plan requires a 50% reduction in energy consumption for public buildings, and a 37% reduction for the commercial sector from 2015 to 2030.</li> </ul>	<ul style="list-style-type: none"> <li>■ <b>Many buildings are rented.</b> Tenants may not have the authority or finances to make capital charged improvements to the building. Owners may also be reluctant to make large investments for energy retrofits because they fear that they may not be able to recoup the investment.</li> </ul>
<ul style="list-style-type: none"> <li>■ <b>Rising energy prices</b> (See <a href="#">Section 2</a>)</li> </ul>	<ul style="list-style-type: none"> <li>■ <b>Economic downturn</b> may mean that it is not affordable, merely for the sake of upgrading, to change aspects of a building that are not necessarily broken.</li> </ul>
<ul style="list-style-type: none"> <li>■ <b>Falling cost of energy efficient building technologies</b> (See <a href="#">Section 2</a>)</li> </ul>	<ul style="list-style-type: none"> <li>■ <b>Lack of local manufacturing industry for energy efficient technologies.</b> For public sector tenders or clients who have to procure locally, the cost of procurement is high because there are very few local manufacturers of energy efficient technologies.</li> </ul>



**DANGER**



UNAUTHORISED ENTRY  
STRICTLY PROHIBITED  
UNAUTHORISED PERSONS  
ARE PROHIBITED FROM  
HANDLING OR INTERFERING  
WITH ELECTRICAL APPARATUS

**LV**

# 5

## Funding and Incentives

**A range of general and sector-funding solutions and incentives is available to investors, manufacturers and service companies in the green economy.**

It covers international sources, such as Development Finance Institutions (DFI), local funding pools including the public and private sector, and a considerable range of tax incentives.

### 5.1. General database web page

The GreenCape Finance Desk hosts a web page<sup>17</sup> with a number of Green Finance resources that cover funding and incentives available to companies in the green economy. A few of the available database are highlighted below.

#### 5.1.1. Green Finance Database

In conjunction with the South African National Energy Development Institute (SANEDI), GreenCape maintains a database of funding sources and primarily dti-driven incentives that may be relevant to green economy investors. The database contains information on more than 100 funding opportunities, including an overview of the opportunity and its contact details and links. It is ideal for any entity seeking a broad range of funding solutions and financial incentives, with South African institutions being the main source of opportunities. The database is available to view and download online<sup>18</sup>.

#### 5.1.2. Government funding and incentives database

An updated document focused on South African government funding and incentives is available to view and download online<sup>19</sup>.

#### 5.1.3. Finfind database

Finfind<sup>20</sup> is an innovative online finance solution that brings together SME finance providers and finance seekers. With a focus on finance readiness, Finfind has more than 200 lenders and over 350 loan products available to SMEs. The database is ideal for South African SMMEs who are seeking funding and/or business advisory services, and those who want to improve their understanding of finance.

#### 5.1.4. AlliedCrowds database

AlliedCrowds<sup>21</sup> is the first complete aggregator and directory of alternative finance providers in the developing world. Sign-up is free and allows users to access a global database where one can filter for sector (including greentech, agriculture and social impact), type of capital (equity, lending, grant), and type of funding (crowdfunding, angel investing, venture capital, impact investing). In addition:

- Themed databases around the Sustainable Development Goals (SDGs) and the World Green Economy Organisation (WGEO) are available.
- Reports, including a number specifically about African funding sources, can also be downloaded for free.
- You can also contact Allied Crowds to create a customised funding database for you.

This resource is ideal for any entity seeking a broad range of financial solutions on a global scale.

<sup>17</sup> <https://www.greencape.co.za/content/focusarea/green-finance-databases>

<sup>18</sup> <https://www.greencape.co.za/assets/Uploads/GreenCape-Finance-Database-v6.xlsx>

<sup>19</sup> <https://www.greencape.co.za/assets/Uploads/Government-Funding-and-Incentive-Booklet.pdf>

<sup>20</sup> [www.finfindeasy.co.za](http://www.finfindeasy.co.za)

<sup>21</sup> <https://alliedcrowds.com/>





# 6

## The Western Cape: Africa's green economy hub

**The Western Cape is a world-class investment destination.**

The province provides businesses and investors with prime locations, modern infrastructure, a skilled workforce, low operational costs and an abundance of natural resources. It is also a sought-after place to live, with unrivalled natural beauty, vibrant culture, excellent schools and universities, and an outstanding quality of life. In 2017, Cape Town was ranked among the top 21 global investment destinations by Foreign Direct Investment (fDi) Intelligence, a division of the Financial Times.

### *A great place for green business*

There are compelling reasons why the Western Cape Province is viewed by many as Africa's green economy hub. Coupled with a strong and rapidly growing market for green technology and services in South Africa and beyond, the Western Cape offers:

- Africa's renewable energy (RE) and cleantech hub, with a critical mass of leading companies present.
- Local presence of major professional services and financiers.
- Significant market opportunities for businesses and investors in agriculture, energy services, utility scale solar and wind, waste, water, bioeconomy and resource efficiency.
- A supportive government that has made ease of doing business and the green economy key priorities.
- Five universities with comprehensive R&D capabilities and dedicated green economy skills programmes.
- A range of investment incentives in the Atlantis Special Economic Zone (SEZ) for Green Technologies.

### *Supporting businesses and investors*

The province also offers dedicated support for businesses and investors focusing on greentech and services, including:

**InvestSA One Stop Shop:** Offers convenient investor support on permits, licensing and registrations - all under one roof.

**GreenCape:** Provides dedicated support and market intelligence to green economy sectors.

**Wesgro:** The official investment and trade promotion agency for the Western Cape.

**SAREBI:** A business incubator providing non-financial support to green entrepreneurs.

**SARETEC:** Offers specialised industry-related and accredited training for the wind and solar industries.

### *Market opportunities in the province and South Africa*

Some of the major market opportunity areas in the province and South Africa in the next five years are outlined in the graphic on the next page (see individual MIRs and the GreenCape website for more information).

### *R&D capabilities and skills*

The region's five universities – University of Cape Town, Stellenbosch University, University of the Western Cape, the Cape Peninsula University of Technology and the George campus of the Nelson Mandela Metropolitan University – underpin all of this with comprehensive research and development (R&D) capabilities and dedicated green economy skills programmes.

# Major market opportunities: Western Cape and South Africa

## Agriculture

### Precision agriculture

Tools, data analysis, local manufacturing & financing.

### Solar energy for agriculture

Minimum market of R120 million (WC) and R420 million (SA) for solar PV in agri & agri-processing.

### Controlled environment agriculture

R600 million potential market (WC), 15% annual growth (WC).

## Energy services (SA-wide)

### Solar PV systems & components

600MWp installed capacity; R1.7bn additional investment in 2018 (R7.7bn to date)

### Local manufacturing & assembly

Solar PV systems and components – systems require compliance with local content regulations

### Energy storage

Keystone of future energy services market; ~R5bn market for demand side management and back-up power by 2035

## Utility scale renewable energy (SA-wide)

### Independent power production

6.3GWp independent power procured, 13.7GWp additional capacity by 2030, based on updated IRP (5.67GWp solar, 8.1GWp wind).

### Rest of Africa

Greater uptake of RE & decentralized systems. Off-take guarantees and local currency debt innovation needed.

### Local manufacturing

Refined local content requirements, with specific components obligated to be locally manufactured e.g. wind towers, tower internals, panel laminating, PV mounting structures

## Waste

### Municipal PPP

Public-private partnership projects of R1.3bn (WC)

### Organic waste treatment

Landfill ban require treatment technologies to process 1 m<sup>3</sup> p.a. of organic waste (WC)

### Alternative waste treatment

Cape Town has highest landfill cost in SA & good business case for AWT. R1bn+ invested by solution providers since 2016 (SA)

## Water

### Industrial and Commercial

Water intense food & bev sectors expected gross capital formation of ~R14bn by 2021

### New developments

Green building certifications increased 25-fold since 2010 (SA)

### Municipal

Significant opportunities in metro markets incl. new R5.8bn (417 MLD) Cape Town augmentation programme (WC)

## Bioeconomy & resource efficiency

### Food value retention

At least R600m retained through improved cold chain management & waste reduction (SA)

### Solar thermal

Already installed: R33m (WC), R135m (SA); ~R3.7bn potential market in agri-processing

### Biogas

For electricity, heating & transport; R100m of installations expected by 2023



# Atlantis Special Economic Zone for Green Technologies

---

The Atlantis SEZ is a zone dedicated to the manufacturing and provision of services in the green technology space - technologies that reduce or reverse the impact of people on the planet. Wind turbines, solar panels, insulation, biofuels, electric vehicles, materials recycling and green building materials are all examples of green technologies that will be welcomed to the zone.

The zone welcomes manufacturers, service providers, suppliers and other players in the value chains of different green technologies.

The SEZ is situated in the Atlantis industrial area north of Cape Town, south of Wesfleur, east of Dassenberg Road, and west of the Witsand community.

## Why invest in the SEZ?

**There are strong and growing South African and African markets for greentech.** The South African greentech manufacturing market is worth at least R30bn; with a growing greentech market in the neighbouring countries. South Africa has opportunities in energy, waste, agriculture, transport and other sectors and is a great entry point for the SADC market.

**Atlantis is a great location and development ready.** 93 hectares of zoned City of Cape Town

land is available for leasing to investors. Bulk infrastructure is in place and Atlantis has new public transport and shipping links and fibre connectivity. Atlantis is also close to major ports, roads, universities and greentech markets.

**Investors have access to extensive investment support** through the One Stop Shop for investor support and the rest of the investor support ecosystem, which includes InvestSA, GreenCape, the City of Cape Town, and Wesgro. Together the ecosystem provides information and advocacy; market intelligence; facilitated access to permits and licenses, planning and development approval; and skills training.

**Investors and tenants are accessing attractive incentives** in the form of tax relief and allowances, employment tax incentives, fast-tracked development approvals, fee exemptions and subsidies.

**There is an attractive, wide-ranging skills base to recruit from** with 5 universities and many more colleges in the province, and a large range of unskilled, semi-skilled, technical and professional candidates.

**For more information, contact the SEZ's Investment Promotion Facilitator, Jarrod Lyons: [jarrod@greencape.co.za](mailto:jarrod@greencape.co.za)**







# 7

## GreenCape's support to businesses and investors

**GreenCape is a non-profit organisation that works at the interface of business, government and academia to identify and remove barriers to economically viable green economy infrastructure solutions. Our vision is a thriving prosperous Africa, mobilised by the green economy.**

Working in developing countries, GreenCape catalyses the replication and large-scale uptake of green economy solutions to enable each country and its citizens to prosper.

We work with businesses, investors, academia and government to help unlock the investment and employment potential of greentech and services, and to support a transition to a resilient green economy.

We assist businesses by removing barriers to their establishment and growth and provide our members with:

- free, credible and impartial market information and insights
- access to networks of key players in government, industry, finance and academia
- an advocacy platform to help create an enabling policy and regulatory environment for green business

We assist local, provincial and national government to build a resilient green economy by providing:

- support on the development of standards, regulations, tools and policies
- expert technical knowledge on key sectors in the green economy
- access to networks of key players across business, academia, and internationally

Since inception in 2010, GreenCape has grown to a multi-disciplinary team of over 40 staff members, representing backgrounds in finance, engineering, environmental science and economics.

**We have facilitated and supported R17bn of investments in renewable energy projects and manufacturing. From these investments, more than 10 000 jobs have been created. Through our WISP (industrial symbiosis) programme, by connecting businesses with waste / under-used resources, we have to date diverted nearly 63,000 tonnes of waste from landfill.**

Our market intelligence reports form part of a working body of information generated by sector desks and projects within GreenCape's three main programmes – energy, waste and resources.

Figure 16 below shows the different focus areas within each of our programmes.

### ***Benefits of becoming a GreenCape member***

We currently have over 1100 members, and offer free membership. Becoming a member of GreenCape will give you access to the latest information regarding developments in the various sectors; access to tools, reports, and project information; and offer you the opportunity – through our networking events – to meet and interact with various stakeholders in the green economy.



— ① **Renewable Energy**

Utility-scale projects, localisation of component manufacturing, incentives & financing options, wheeling & energy trading.

— ② **Energy Services**

Energy efficiency & embedded generation, electric vehicles, alternative basic electrification, incentives & financing options.

— ③ **Alternative Waste Treatment**

Municipal decision-making & policy & legislative tools on alternative waste treatment options; small-scale biogas, recycling & reuse (dry recyclables, construction & demolition waste).

— ④ **Western Cape Industrial Symbiosis Programme (WISP)**

The team matches businesses to share unused resources, cut costs & create value. They also support entrepreneurs to identify & realise new business opportunities in the waste industry.

— ⑤ **Water**

Water provision & economic development; greentech opportunities for water use efficiency, treatment & reuse, business water resilience.

— ⑥ **Sustainable Agriculture**

Precision-, conservation- and controlled environment- agriculture; valorisation of wastes to high value bio- products, including bio-energy.

**Figure 16: GreenCape's focus areas**

**Support through the International Cleantech Network**

GreenCape's membership of the International Cleantech Network (ICN) gives our members access to international business opportunities in countries where other cleantech clusters are based (mainly Europe and North America).

To become a member or to get your ICN passport, please contact GreenCape or visit our website: [www.greencape.co.za](http://www.greencape.co.za)

# 8

## References

- Department of Tourism. 2017. The Green Tourism Incentive Programme. Available from: <<https://goo.gl/XkWBkK>> Accessed 01 November 2017.
- Eskom. 2017. Historical average price increase. Available from: <<https://goo.gl/eaAC9W>> Accessed 08 November 2017.
- Eskom. 2018. Tariffs and charges (Megaflex tariff). Available from: <[http://www.eskom.co.za/CustomerCare/TariffsAndCharges/Pages/Tariffs\\_And\\_Charges.aspx](http://www.eskom.co.za/CustomerCare/TariffsAndCharges/Pages/Tariffs_And_Charges.aspx)> Accessed 14 March 2018.
- Global Innovation Lab for Climate Finance (The Lab). 2018. Pay As You Save for Clean Transport – Instrument Analysis. Available from: <[https://www.climatefinancelab.org/wp-content/uploads/2018/02/Pay-As-You-Save-for-Clean-Transport\\_Instrument-Overview.pdf](https://www.climatefinancelab.org/wp-content/uploads/2018/02/Pay-As-You-Save-for-Clean-Transport_Instrument-Overview.pdf)> Accessed 12 October 2018.
- International Energy Agency (IEA). 2014. Africa Energy Outlook: A focus on energy prospects in Sub-Saharan Africa, World Energy Outlook special report. Available from: <<https://goo.gl/LxBaP0>> Accessed 07 December 2017.
- International Energy Agency (IEA). 2017. South Africa: Balances for 2015. Available from: <<https://goo.gl/ttzcta>> Accessed 27 November 2017.
- International Finance Corporation (IFC). 2017a. Energy storage trends and opportunities in emerging markets. Available from: <<https://goo.gl/PbVbDu>> Accessed 07 December 2017.
- International Finance Corporation. 2017b. Green buildings market intelligence: South Africa company profile. Available from: <<https://goo.gl/ciscic>> Accessed 04 December 2017.
- International Renewable Energy Agency (IRENA). 2017. Levelised cost of electricity 2010–2016. Available from: <<http://resourceirena.irena.org/gateway/dashboard/?topic=3&subTopic=1057>> Accessed 08 November 2017.
- International Renewable Energy Agency (IRENA). 2018. Renewable Power Generation Costs in 2017. International Renewable Energy Agency, Abu Dhabi. Available from: <[https://www.irena.org/-/media/Files/IRENA/Agency/Publication/2018/Jan/IRENA\\_2017\\_Power\\_Costs\\_2018.pdf](https://www.irena.org/-/media/Files/IRENA/Agency/Publication/2018/Jan/IRENA_2017_Power_Costs_2018.pdf)> Accessed 11 November 2018.
- Modise, M. 2013. Overview on the National Energy Efficiency Strategy (NEES) Post 2015. Presentation given at the Integrated Energy Plan Public Workshop. Available from: <[http://www.energy.gov.za/files/IEP/jhb\\_workshop/Overview-on-the-National-Energy-Efficiency-Strategy-Post2015-26Sep2013.pdf](http://www.energy.gov.za/files/IEP/jhb_workshop/Overview-on-the-National-Energy-Efficiency-Strategy-Post2015-26Sep2013.pdf)> Accessed 19 December 2017.
- National Business Initiative (NBI). 2016. The Private Sector Energy Efficiency Programme: two years of focused energy-efficiency interventions in the private sector 2013–2015. Available from: <<https://goo.gl/Qxozid>> Accessed 06 November 2017.
- National Cleaner Production Centre South Africa (NCPC-SA). 2017. Annual Highlights 2016/17. Available from: <<https://goo.gl/HtnkQR>> Accessed 02 November 2017.
- National Treasury. 2016a. Package of measures to deal with climate change: The carbon tax and energy efficiency tax incentive. Johannesburg: s.n.
- National Treasury. 2016b. Minimum threshold for local production and content for solar photovoltaic systems and components. Pretoria: National Treasury.
- Navigant Research 2017. ESCo Market Overview. Available from: <<https://www.navigantresearch.com/research/esco-market-overview>> Accessed 03 November 2017.
- PQRS. 2018. The PV quality assurance program. Available from: <<https://pqrs.co.za/the-pv-quality-assurance-program/>> Accessed 16 November 2018.

PQRS. 2017a. Database Q2 2017 [Microsoft Excel Spreadsheet]. Cape Town: PQRS.

PQRS. 2017b. Demystifying the total installed PV capacity for South Africa Nov 2016. Available from: <<http://pqrs.co.za/data/demystifying-the-total-installed-pv-capacity-for-south-africa-nov-2016/>> Accessed 29 November 2017.

PV GreenCard. 2018. The PV GreenCard. Available from: <<https://www.pvgreencard.co.za/>> Accessed 16 November 2018.

SALGA. 2017. Status of Small Scale Embedded Generation (SSEG) In South African Municipalities. Available from: <<https://google.com/search?q=9hhnDf>> Accessed 12 November 2018.

SALGA. 2018. Telephonic conversation.  
SANEDI. 2016. Energy storage and South Africa. Available from: <<http://www.sapvia.co.za/wp-content/uploads/2016/11/Energy-Storage-SAPVIA-Nov2016.pdf>> Accessed 27 November 2017.

SAPVIA. 2018. Role of SAPVIA. Available from: <<http://www.sapvia.co.za/role-of-sapvia/>> Accessed 16 November 2018.

SAWEA. 2018. Vision and Purpose. Available from: <<https://sawea.org.za/about/>> Accessed 16 November 2018.

South Africa. 1962. Income Tax Act, No. 58 of 1962, Section 12. Pretoria: Government Printer. Available online: <<http://sars.mylexisnexus.co.za/>> Accessed 12 March 2018.

Statistics South Africa. 2017. CPI History. Available from: <<http://www.statssa.gov.za/publications/P0141/CPIHistory.pdf?>> Accessed 08 November 2017.



